

Actuated Valves

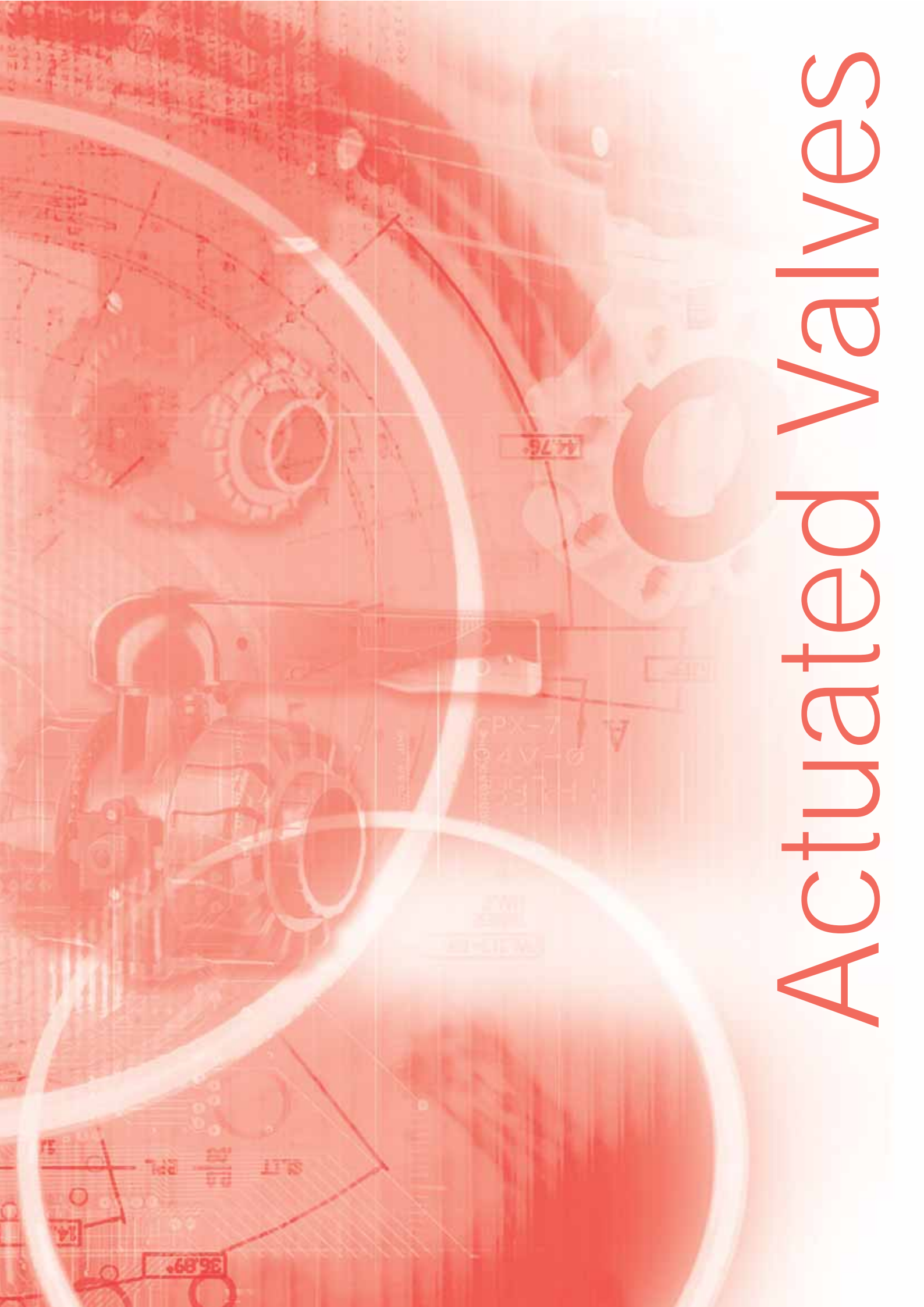

Understanding actuated codes and pricing

Firstly establish the specification of the type of actuation that is needed. In the example below this is a H1 DK* ***, an electric actuated double union ball valve (VKD). Once the actuation required has been identified, make a note of the list price.

Now the code needs finalising to identify the full specification of the manual valve, i.e. material of the body, size etc. In the appropriate Manual section of this price list, find the code associated with the product needed. In this example it will be found under double union ball valves (VKD) in the ABS section. This will give a code similar to HO DKB 106, a 1½" double union ball valve in ABS with FPM seals, where the 1st, 3rd and 4th characters will be the same as the actuated code already identified, in this instance HDK. Again make a note of the list price.

Now combine the codes. Use the first 4 digits of the actuated code together with the last 4 of the manual code. This will give a unique 8 digit code, in this instance H1DKB106, with the cost being the sum of the manual and actuated list prices, e.g. (£116.93 + £320.76 = £437.69).

For further explanation on how the coding system works, refer to the table on page 5 or alternatively contact our Valve Department on 01543 272424.

Durapipe FIP valves are coded in a simple and logical manner, each box containing information about the valve required:

Example:

H	1	D	K	B	1	0	6
---	---	---	---	---	---	---	---

- H** = Prefixes all valve orders
- 1** = Type of operation/actuator
In this example: Electrical 100 to 240v
- D K** = Type of valve
In this example: VKD Double union ball
- B** = Body and seals details
In this example: ABS body with FPM seals
- 1 0 6** = Valve size
In this example: to suit a pipe of 1½" nominal bore

To order, simply select the appropriate combination from page 4 or page 76 in this catalogue.

Valve type	Actuation available	
	Electrical	Pneumatic
Butterfly	*	*
Diaphragm		*
Ball	*	*
Angle seat		*

Durapipe FIP Manual and Actuated valves pricing method

Below is an example of how to calculate the price of a manual and actuated valve combination:

Manual valve				Actuated valve					
Description	Product Code	Page Number	Price Each (£)	Description	Product Code	Page Number	Price Each (£)	Combined Code	Total Price (£)
1½" ABS VKD double union ball valve with FPM seals	HO DKB 106	34	£116.93	VKD Electric Actuated - Standard 100 to 240v AC	H1 DK	65	£320.76	HI DKB 106	£437.69

VKD DOUBLE UNION BALL VALVES

3/8" -d16 to 2"-d63

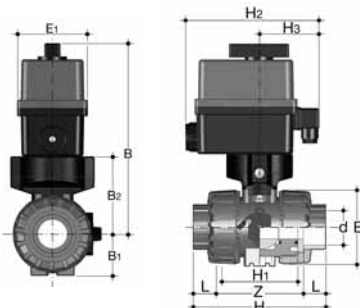

2 1/2" -d75 to 4"-d110

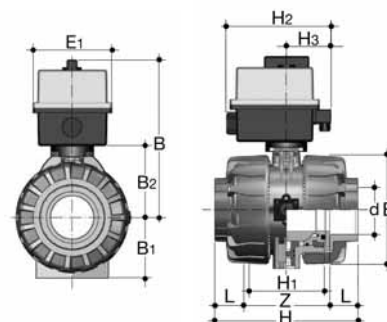

VKD Electric actuated - Standard

G	d	DN	PN*	B	H	B1	B2	E1	H2	H3	ACT	Product Code	List Price (£)	Product Code	List Price (£)
												100 to 240 v AC		24 v AC/DC	
3/8	16	10	16	205	103	29	58	92	187	82	EA2	H1 DK* ***	£320.76	H2 DK* ***	£320.76
1/2	20	15	16	205	103	29	58	92	187	82	EA2	H1 DK* ***	£320.76	H2 DK* ***	£320.76
3/4	25	20	16	220.5	115	34.5	73.5	92	187	82	EA2	H1 DK* ***	£320.76	H2 DK* ***	£320.76
1	32	25	16	221	128	39	74	92	187	82	EA2	H1 DK* ***	£320.76	H2 DK* ***	£320.76
1 1/4	40	32	16	244	146	46	97	92	187	82	EA2	H1 DK* ***	£320.76	H2 DK* ***	£320.76
1 1/2	50	40	16	251	164	52	104	92	187	82	EA2	H1 DK* ***	£320.76	H2 DK* ***	£320.76
2	63	50	10**	261	199	62	114	92	187	82	EA2	H1 DK* ***	£320.76	H2 DK* ***	£320.76
2 1/2	75	65	16	295	235	87	119	128	188	93	EA3	H1 DK* ***	£428.76	H2 DK* ***	£428.76
3	90	80	16	308	270	105	132	128	188	93	EA3	H1 DK* ***	£428.76	H2 DK* ***	£428.76
4	110	100	10**	325	308	129	150	128	188	93	EA3	H1 DK* ***	£428.76	H2 DK* ***	£428.76

VKD Electrically Actuated - Fail safe closed

G	d	DN	PN*	B	H	B1	B2	E1	H2	H3	ACT	Product Code	List Price (£)	Product Code	List Price (£)
												100 to 240 v AC		24 v AC/DC	
3/8	16	10	16	205	103	29	58	92	187	82	EB2	H3 DK* ***	£459.00	H4 DK* ***	£459.00
1/2	20	15	16	205	103	29	58	92	187	82	EB2	H3 DK* ***	£459.00	H4 DK* ***	£459.00
3/4	25	20	16	220.5	115	34.5	73.5	92	187	82	EB2	H3 DK* ***	£459.00	H4 DK* ***	£459.00
1	32	25	16	221	128	39	74	92	187	82	EB2	H3 DK* ***	£459.00	H4 DK* ***	£459.00
1 1/4	40	32	16	244	146	46	97	92	187	82	EB2	H3 DK* ***	£459.00	H4 DK* ***	£459.00
1 1/2	50	40	16	251	164	52	104	92	187	82	EB2	H3 DK* ***	£459.00	H4 DK* ***	£459.00
2	63	50	10**	261	199	62	114	92	187	82	EB2	H3 DK* ***	£459.00	H4 DK* ***	£459.00
2 1/2	75	65	16	295	235	87	119	128	188	93	EB3	H3 DK* ***	£569.16	H4 DK* ***	£569.16
3	90	80	16	308	270	105	132	128	188	93	EB3	H3 DK* ***	£569.16	H4 DK* ***	£569.16
4	110	100	10**	325	308	129	150	128	188	93	EB3	H3 DK* ***	£569.16	H4 DK* ***	£569.16

VKD Electrically Actuated - Fail safe open

G	d	DN	PN*	B	H	B1	B2	E1	H2	H3	ACT	Product Code	List Price (£)	Product Code	List Price (£)
												100 to 240 v AC		24 v AC/DC	
3/8	16	10	16	205	103	29	58	92	187	82	EB2	H5 DK* ***	£459.00	H6 DK* ***	£459.00
1/2	20	15	16	205	103	29	58	92	187	82	EB2	H5 DK* ***	£459.00	H6 DK* ***	£459.00
3/4	25	20	16	220.5	115	34.5	73.5	92	187	82	EB2	H5 DK* ***	£459.00	H6 DK* ***	£459.00
1	32	25	16	221	128	39	74	92	187	82	EB2	H5 DK* ***	£459.00	H6 DK* ***	£459.00
1 1/4	40	32	16	244	146	46	97	92	187	82	EB2	H5 DK* ***	£459.00	H6 DK* ***	£459.00
1 1/2	50	40	16	251	164	52	104	92	187	82	EB2	H5 DK* ***	£459.00	H6 DK* ***	£459.00
2	63	50	10**	261	199	62	114	92	187	82	EB2	H5 DK* ***	£459.00	H6 DK* ***	£459.00
2 1/2	75	65	16	295	235	87	119	128	188	93	EB3	H5 DK* ***	£569.16	H6 DK* ***	£569.16
3	90	80	16	308	270	105	132	128	188	93	EB3	H5 DK* ***	£569.16	H6 DK* ***	£569.16
4	110	100	10**	325	308	129	150	128	188	93	EB3	H5 DK* ***	£569.16	H6 DK* ***	£569.16

VKD Electrically Actuated - 4 to 20mA Positioning

G	d	DN	PN*	B	H	B1	B2	E1	H2	H3	ACT	Product Code	List Price (£)	Product Code	List Price (£)
												100 to 240 v AC		24 v AC/DC	
3/8	16	10	16	205	103	29	58	92	187	82	EM2	H7 DK* ***	£491.40	H8 DK* ***	£491.40
1/2	20	15	16	205	103	29	58	92	187	82	EM2	H7 DK* ***	£491.40	H8 DK* ***	£491.40
3/4	25	20	16	220.5	115	34.5	73.5	92	187	82	EM2	H7 DK* ***	£491.40	H8 DK* ***	£491.40
1	32	25	16	221	128	39	74	92	187	82	EM2	H7 DK* ***	£491.40	H8 DK* ***	£491.40
1 1/4	40	32	16	244	146	46	97	92	187	82	EM2	H7 DK* ***	£491.40	H8 DK* ***	£491.40
1 1/2	50	40	16	251	164	52	104	92	187	82	EM2	H7 DK* ***	£491.40	H8 DK* ***	£491.40
2	63	50	10**	261	199	62	114	92	187	82	EM2	H7 DK* ***	£491.40	H8 DK* ***	£491.40
2 1/2	75	65	16	295	235	87	119	128	188	93	EM3	H7 DK* ***	£601.56	H8 DK* ***	£601.56
3	90	80	16	308	270	105	132	128	188	93	EM3	H7 DK* ***	£601.56	H8 DK* ***	£601.56
4	110	100	10**	325	308	129	150	128	188	93	EM3	H7 DK* ***	£601.56	H8 DK* ***	£601.56

* PP PN 10 bar

Actuated valve prices are calculated by adding the above prices to the relevant manual valve prices, see page 64 for example.

** DN50/DN100 PN16 available on request

VKD DOUBLE UNION BALL VALVES

3/8" -d16 to 2"-d63

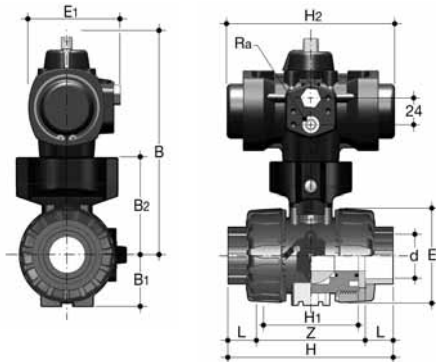

2 1/2" -d75 to 4"-d110

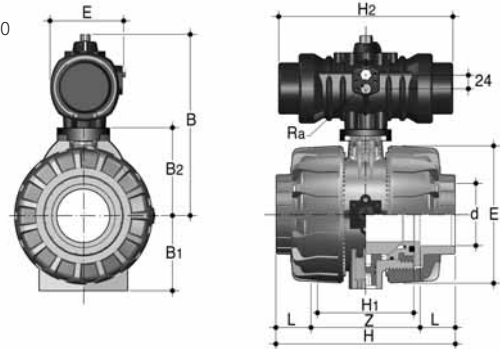

VKD Pneumatically Actuated - Fail safe closed

G	d	DN	PN*	B	H	B1	B2	E1	H2	ACT	Product Code	List Price (£)
3/8	16	10	16	143	103	29	58	68.5	142	PA1/S	HP DK* ***	£174.96
1/2	20	15	16	143	103	29	58	68.5	142	PA1/S	HP DK* ***	£174.96
3/4	25	20	16	158.5	115	34.5	73.5	68.5	142	PA1/S	HP DK* ***	£174.96
1	32	25	16	184	128	39	74	80	155	PA2/S	HP DK* ***	£174.96
1 1/4	40	32	16	207	146	46	97	80	155	PA2/S	HP DK* ***	£174.96
1 1/2	50	40	16	214	164	52	104	102	230	PA3/S	HP DK* ***	£198.29
2	63	50	16	224	199	62	114	102	230	PA3/S	HP DK* ***	£198.29
2 1/2	75	65	16	281	235	87	119	125	304	PA4/S	HP DK* ***	£297.43
3	90	80	16	294	270	105	132	125	304	PA4/S	HP DK* ***	£297.43
4	110	100	16	312	308	129	150	125	304	PA4/S	HP DK* ***	£297.43

VKD Pneumatically Actuated - Fail safe open

G	d	DN	PN*	B	H	B1	B2	E1	H2	ACT	Product Code	List Price (£)
3/8	16	10	16	143	103	29	58	68.5	142	PA1/S	HQ DK* ***	£174.96
1/2	20	15	16	143	103	29	58	68.5	142	PA1/S	HQ DK* ***	£174.96
3/4	25	20	16	158.5	115	34.5	73.5	68.5	142	PA1/S	HQ DK* ***	£174.96
1	32	25	16	184	128	39	74	80	155	PA2/S	HQ DK* ***	£174.96
1 1/4	40	32	16	207	146	46	97	80	155	PA2/S	HQ DK* ***	£174.96
1 1/2	50	40	16	214	164	52	104	102	230	PA3/S	HQ DK* ***	£198.29
2	63	50	16	224	199	62	114	102	230	PA3/S	HQ DK* ***	£198.29
2 1/2	75	65	16	281	235	87	119	125	304	PA4/S	HQ DK* ***	£297.43
3	90	80	16	294	270	105	132	125	304	PA4/S	HQ DK* ***	£297.43
4	110	100	16	312	308	129	150	125	304	PA4/S	HQ DK* ***	£297.43

VKD Pneumatically Actuated - Double acting

G	d	DN	PN*	B	H	B1	B2	E1	H2	ACT	Product Code	List Price (£)
3/8	16	10	16	143	103	29	58	68.5	107	PA1	HR DK* ***	£174.96
1/2	20	15	16	143	103	29	58	68.5	107	PA1	HR DK* ***	£174.96
3/4	25	20	16	158.5	115	34.5	73.5	68.5	107	PA1	HR DK* ***	£174.96
1	32	25	16	158.5	128	39	74	68.5	107	PA1	HR DK* ***	£174.96
1 1/4	40	32	16	207	146	46	97	80	125	PA2	HR DK* ***	£174.96
1 1/2	50	40	16	214	164	52	104	80	125	PA2	HR DK* ***	£174.96
2	63	50	16	224	199	62	114	102	182	PA3	HR DK* ***	£198.29
2 1/2	75	65	16	247	235	87	119	102	182	PA3	HR DK* ***	£204.12
3	90	80	16	294	270	105	132	125	233	PA4	HR DK* ***	£204.12
4	110	100	16	312	308	129	150	125	233	PA4	HR DK* ***	£297.43

* PP PN 10 bar

Actuated valve prices are calculated by adding the above prices to the relevant manual valve prices, see page 64 for example.

VKD DOUBLE UNION BALL VALVES

3/8" -d16 to 2"-d63

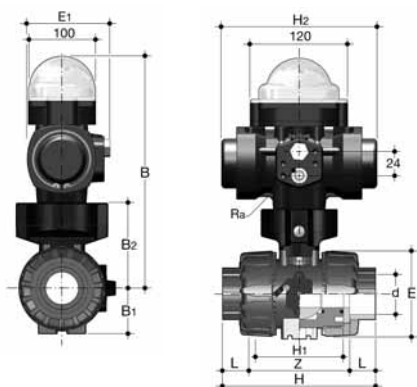

2 1/2" -d75 to 4"-d110

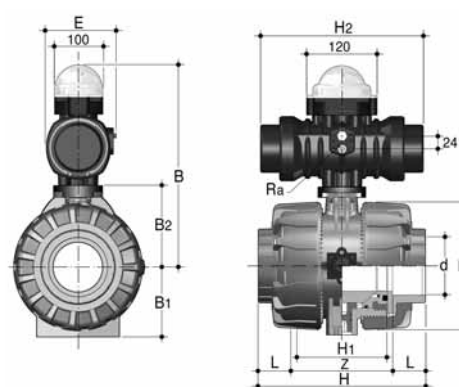

VKD Pneumatically Actuated - Fail safe closed with switch box

G	d	DN	PN*	B	H	B1	B2	E1	H2	ACT	Product Code	List Price (£)
3/8	16	10	16	228	103	29	58	68.5	142	PA1/S	HS DK* ***	£255.96
1/2	20	15	16	228	103	29	58	68.5	142	PA1/S	HS DK* ***	£255.96
3/4	25	20	16	244	115	34.5	73.5	68.5	142	PA1/S	HS DK* ***	£255.96
1	32	25	16	269	128	39	74	80	155	PA2/S	HS DK* ***	£255.96
1 1/4	40	32	16	292	146	46	97	80	155	PA2/S	HS DK* ***	£255.96
1 1/2	50	40	16	299	164	52	104	102	230	PA3/S	HS DK* ***	£279.29
2	63	50	16	309	199	62	114	102	230	PA3/S	HS DK* ***	£279.29
2 1/2	75	65	16	366	235	87	119	125	304	PA4/S	HS DK* ***	£378.43
3	90	80	16	379	270	105	132	125	304	PA4/S	HS DK* ***	£378.43
4	110	100	16	397	308	129	150	125	304	PA4/S	HS DK* ***	£378.43

VKD Pneumatically Actuated - Fail safe open with switch box

G	d	DN	PN*	B	H	B1	B2	E1	H2	ACT	Product Code	List Price (£)
3/8	16	10	16	228	103	29	58	68.5	142	PA1/S	HT DK* ***	£255.96
1/2	20	15	16	228	103	29	58	68.5	142	PA1/S	HT DK* ***	£255.96
3/4	25	20	16	244	115	34.5	73.5	68.5	142	PA1/S	HT DK* ***	£255.96
1	32	25	16	269	128	39	74	80	155	PA2/S	HT DK* ***	£255.96
1 1/4	40	32	16	292	146	46	97	80	155	PA2/S	HT DK* ***	£255.96
1 1/2	50	40	16	299	164	52	104	102	230	PA3/S	HT DK* ***	£279.29
2	63	50	16	309	199	62	114	102	230	PA3/S	HT DK* ***	£279.29
2 1/2	75	65	16	366	235	87	119	125	304	PA4/S	HT DK* ***	£378.43
3	90	80	16	379	270	105	132	125	304	PA4/S	HT DK* ***	£378.43
4	110	100	16	397	308	129	150	125	304	PA4/S	HT DK* ***	£378.43

VKD Pneumatically Actuated - Double acting with switch box

G	d	DN	PN*	B	H	B1	B2	E1	H2	ACT	Product Code	List Price (£)
3/8	16	10	16	228	103	29	58	68.5	107	PA1	HU DK* ***	£255.96
1/2	20	15	16	228	103	29	58	68.5	107	PA1	HU DK* ***	£255.96
3/4	25	20	16	244	115	34.5	73.5	68.5	107	PA1	HU DK* ***	£255.96
1	32	25	16	244	128	39	74	68.5	107	PA1	HU DK* ***	£255.96
1 1/4	40	32	16	292	146	46	97	80	125	PA2	HU DK* ***	£255.96
1 1/2	50	40	16	299	164	52	104	80	125	PA2	HU DK* ***	£255.96
2	63	50	16	309	199	62	114	102	182	PA3	HU DK* ***	£279.29
2 1/2	75	65	16	332	235	87	119	102	182	PA3	HU DK* ***	£285.12
3	90	80	16	379	270	105	132	125	233	PA4	HU DK* ***	£285.12
4	110	100	16	397	308	129	150	125	233	PA4	HU DK* ***	£378.43

* PP PN 10 bar

Actuated valve prices are calculated by adding the above prices to the relevant manual valve prices, see page 64 for example.

TKD 3-WAY BALL VALVES

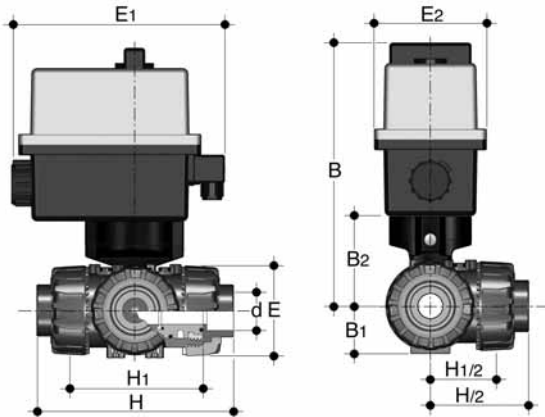

TKD Electric Actuated - Standard

G	d	DN	B	B1	B2	E	E1	E2	H	H1	Product Code	List Price (£)	Product Code	List Price (£)	
												100 to 240 v AC		24 v AC/DC	
3/8	16	10	204.5	29	58	54	187	92	118	80	H1 (T/L)T ****	£320.76	H2 (T/L)T ****	£320.76	
1/2	20	15	204.5	29	58	54	187	92	118	80	H1 (T/L)T ****	£320.76	H2 (T/L)T ****	£320.76	
3/4	25	20	215.5	34.5	69	65	187	92	145	100	H1 (T/L)T ****	£320.76	H2 (T/L)T ****	£320.76	
1	32	25	220.5	39	74	73	187	92	160	110	H1 (T/L)T ****	£320.76	H2 (T/L)T ****	£320.76	
1 1/4	40	32	255.5	46	91	86	187	92	188.5	131	H1 (T/L)T ****	£320.76	H2 (T/L)T ****	£320.76	
1 1/2	50	40	259.5	52	97	98	187	92	219	148	H1 (T/L)T ****	£320.76	H2 (T/L)T ****	£320.76	
2	63	50	279.5	62	114	122	187	92	266.5	179	H1 (T/L)T ****	£320.76	H2 (T/L)T ****	£320.76	

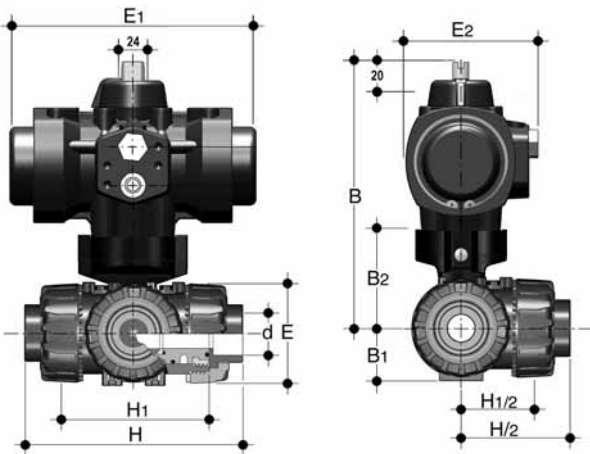

TKD Pneumatic Actuated - Standard

G	d	DN	B	B1	B2	E	E1	E2	H	H1	Product Code	List Price (£)	Product Code	List Price (£)	
												Spring Return		Double Acting	
3/8	16	10	144.5	29	58	54	138	75	118	80	HP (T/L)T ****	£174.96	HR (T/L)T ****	£174.96	
1/2	20	15	160.5	29	58	54	138	75	118	80	HP (T/L)T ****	£174.96	HR (T/L)T ****	£174.96	
3/4	25	20	171.5	34.5	69	65	155.5	86	145	100	HP (T/L)T ****	£174.96	HR (T/L)T ****	£174.96	
1	32	25	176.5	39	74	73	155.5	86	160	110	HP (T/L)T ****	£174.96	HR (T/L)T ****	£174.96	
1 1/4	40	32	195.5	46	91	86	155.5	86	188.5	131	HP (T/L)T ****	£174.96	HR (T/L)T ****	£174.96	
1 1/2	50	40	199.5	52	97	98	155.5	86	219	148	HP (T/L)T ****	£174.96	HR (T/L)T ****	£174.96	
2	63	50	233.5	62	114	122	210	94	266.5	179	HP (T/L)T ****	£174.96	HR (T/L)T ****	£174.96	

Actuated valve prices are calculated by adding the above prices to the relevant manual valve prices, see page 64 for example.

FK BUTTERFLY VALVES

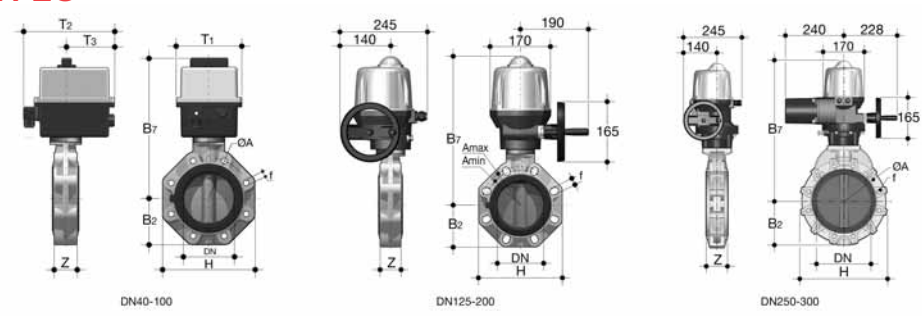

FK Electrically Actuated - Standard

G	d	DN	PN	B7	Z	B2	H	T1	T2	T3	ACT	Product Code	List Price (£)	Product Code	List Price (£)
												100 to 240 v AC		24 v AC/DC	
1½	50	40	16	253	33	60	132	92	189	91	EA2	H1 FK* 106	£320.76	H2 FK* 106	£320.76
2	63	50	16	259	43	70	147	92	189	91	EA2	H1 FK* 107	£320.76	H2 FK* 107	£320.76
2½	75	65	10	266	46	80	165	92	189	91	EA2	H1 FK* 108	£320.76	H2 FK* 108	£320.76
3	90	80	10	308	49	93	185	128	204	96	EA3	H1 FK* 109	£428.76	H2 FK* 109	£428.76
4	110	100	10	322	56	107	211	128	204	96	EA3	H1 FK* 110	£428.76	H2 FK* 110	£428.76
5	140	125	10	425	64	120	240	-	-	-	EA5	H1 FK* 111	£644.76	H2 FK* 111	£644.76
6	160	150	10	438	70	134	268	-	-	-	EA5	H1 FK* 112	£644.76	H2 FK* 112	£644.76
8	225	200	10	435	71	161	323	-	-	-	EA6	H1 FK* 113	£698.76	H2 FK* 113	£698.76
10"	280	250	10	597	114	210	405	-	-	-	EA8	H1 FK* 114	£915.62	H2 FK* 114	£915.62
12	315	300	8	654	114	245	475	-	-	-	EA8	H1 FK* 115	£915.62	H2 FK* 115	£915.62

FK Electrically Actuated - Fail Safe Closed

G	d	DN	PN	B7	Z	B2	H	T1	T2	T3	ACT	Product Code	List Price (£)	Product Code	List Price (£)
												100 to 240 v AC		24 v AC/DC	
1½	50	40	16	253	33	60	132	92	189	91	EB2	H3 FK* 106	£459.00	H4 FK* 106	£459.00
2	63	50	16	259	43	70	147	92	189	91	EB2	H3 FK* 107	£459.00	H4 FK* 107	£459.00
2½	75	65	10	266	46	80	165	92	189	91	EB2	H3 FK* 108	£459.00	H4 FK* 108	£459.00
3	90	80	10	308	49	93	185	128	204	96	EB3	H3 FK* 109	£569.16	H4 FK* 109	£569.16
4	110	100	10	322	56	107	211	128	204	96	EB3	H3 FK* 110	£569.16	H4 FK* 110	£569.16
5	140	125	10	425	64	120	240	-	-	-	EB5	H3 FK* 111	£884.34	H4 FK* 111	£884.34
6	160	150	10	438	70	134	268	-	-	-	EB5	H3 FK* 112	£884.34	H4 FK* 112	£884.34
8	225	200	10	435	71	161	323	-	-	-	EB6	H3 FK* 113	£938.34	H4 FK* 113	£938.34
10	280	250	10	597	114	210	405	-	-	-	EB8	H3 FK* 114	£1,155.20	H4 FK* 114	£1,155.20
12	315	300	8	654	114	245	475	-	-	-	EB8	H3 FK* 115	£1,155.20	H4 FK* 115	£1,155.20

FK Electrically Actuated - Fail Safe Open

G	d	DN	PN	B7	Z	B2	H	T1	T2	T3	ACT	Product Code	List Price (£)	Product Code	List Price (£)
												100 to 240 v AC		24 v AC/DC	
1½	50	40	16	253	33	60	132	92	189	91	EB2	H5 FK* 106	£459.00	H6 FK* 106	£459.00
2	63	50	16	259	43	70	147	92	189	91	EB2	H5 FK* 107	£459.00	H6 FK* 107	£459.00
2½	75	65	10	266	46	80	165	92	189	91	EB2	H5 FK* 108	£459.00	H6 FK* 108	£459.00
3	90	80	10	308	49	93	185	128	204	96	EB3	H5 FK* 109	£569.16	H6 FK* 109	£569.16
4	110	100	10	322	56	107	211	128	204	96	EB3	H5 FK* 110	£569.16	H6 FK* 110	£569.16
5	140	125	10	425	64	120	240	-	-	-	EB5	H5 FK* 111	£884.34	H6 FK* 111	£884.34
6	160	150	10	438	70	134	268	-	-	-	EB5	H5 FK* 112	£884.34	H6 FK* 112	£884.34
8	225	200	10	435	71	161	323	-	-	-	EB6	H5 FK* 113	£938.34	H6 FK* 113	£938.34
10	280	250	10	597	114	210	405	-	-	-	EB8	H5 FK* 114	£1,155.20	H6 FK* 114	£1,155.20
12	315	300	8	654	114	245	475	-	-	-	EB8	H5 FK* 115	£1,155.20	H6 FK* 115	£1,155.20

FK Electrically Actuated - 4 to 20mA Positioning

G	d	DN	PN	B7	Z	B2	H	T1	T2	T3	ACT	Product Code	List Price (£)	Product Code	List Price (£)
												100 to 240 v AC		24 v AC/DC	
1½	50	40	16	253	33	60	132	92	189	91	EM2	H7 FK* 106	£491.40	H8 FK* 106	£491.40
2	63	50	16	259	43	70	147	92	189	91	EM2	H7 FK* 107	£491.40	H8 FK* 107	£491.40
2½	75	65	10	266	46	80	165	92	189	91	EM2	H7 FK* 108	£491.40	H8 FK* 108	£491.40
3	90	80	10	308	49	93	185	128	204	96	EM3	H7 FK* 109	£601.56	H8 FK* 109	£601.56
4	110	100	10	322	56	107	211	128	204	96	EM3	H7 FK* 110	£601.56	H8 FK* 110	£601.56
5	140	125	10	425	64	120	240	-	-	-	EM5	H7 FK* 111	£1066.55	H8 FK* 111	£785.16
6	160	150	10	438	70	134	268	-	-	-	EM5	H7 FK* 112	£1066.55	H8 FK* 112	£785.16
8	225	200	10	435	71	161	323	-	-	-	EM6	H7 FK* 113	£1,120.55	H8 FK* 113	£1,033.56
10	280	250	10	597	114	210	405	-	-	-	EM8	H7 FK* 114	POA	H8 FK* 114	POA
12	315	300	8	654	114	245	475	-	-	-	EM8	H7 FK* 115	POA	H8 FK* 115	POA

Actuated valve prices are calculated by adding the above prices to the relevant manual valve prices, see page 64 for example.

FK BUTTERFLY VALVES

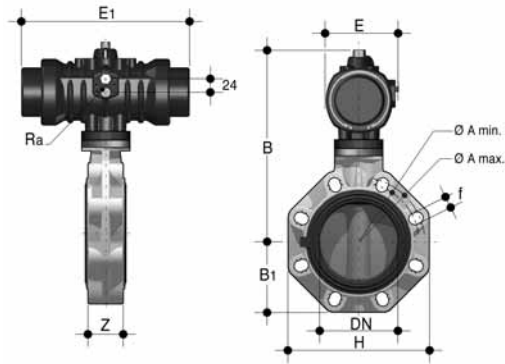

FK Pneumatically Actuated - Fail safe closed

G	d	DN	PN	B	Z	B1	H	E1	E	ACT	Product Code	List Price (£)
1½	50	40	16	234	33	60	132	230	102	PA3/S	HP FK* 106	£198.29
2	63	50	16	240	43	70	147	230	102	PA3/S	HP FK* 107	£198.29
2½	75	65	10	247	46	80	165	230	102	PA3/S	HP FK* 108	£198.29
3	90	80	10	295	49	93	185	304	125	PA4/S	HP FK* 109	£275.40
4	110	100	10	309	56	107	211	304	125	PA4/S	HP FK* 110	£275.40
5	140	125	10	329	64	120	240	479	177	PA6/S	HP FK* 111	£361.80
6	160	150	10	342	70	134	268	479	177	PA6/S	HP FK* 112	£361.80
8	225	200	10	438	71	161	323	479	177	PA6/S	HP FK* 113	£361.80
10	280	250	10	520	114	210	405	598	226	PA7/S	HP FK* 114	£950.40
12	315	300	8	577	114	245	475	598	226	PA7/S	HP FK* 115	£950.40

FK Pneumatically Actuated - Fail safe open

G	d	DN	PN	B	Z	B1	H	E1	E	ACT	Product Code	List Price (£)
1½	50	40	16	234	33	60	132	230	102	PA3/S	HQ FK* 106	£198.29
2	63	50	16	240	43	70	147	230	102	PA3/S	HQ FK* 107	£198.29
2½	75	65	10	247	46	80	165	230	102	PA3/S	HQ FK* 108	£198.29
3	90	80	10	295	49	93	185	304	125	PA4/S	HQ FK* 109	£275.40
4	110	100	10	309	56	107	211	304	125	PA4/S	HQ FK* 110	£275.40
5	140	125	10	329	64	120	240	479	177	PA6/S	HQ FK* 111	£361.80
6	160	150	10	342	70	134	268	479	177	PA6/S	HQ FK* 112	£361.80
8	225	200	10	438	71	161	323	479	177	PA6/S	HQ FK* 113	£361.80
10	280	250	10	520	114	210	405	598	226	PA7/S	HQ FK* 114	£950.40
12	315	300	8	577	114	245	475	598	226	PA7/S	HQ FK* 115	£950.40

FK Pneumatically Actuated - Double acting

G	d	DN	PN	B	Z	B1	H	E1	E	ACT	Product Code	List Price (£)
1½	50	40	16	216	33	60	132	125	80	PA2	HR FK* 106	£198.29
2	63	50	16	222	43	70	147	125	80	PA2	HR FK* 107	£198.29
2½	75	65	10	247	46	80	165	182	102	PA3	HR FK* 108	£198.29
3	90	80	10	261	49	93	185	182	102	PA3	HR FK* 109	£275.40
4	110	100	10	275	56	107	211	182	102	PA3	HR FK* 110	£275.40
5	140	125	10	295	64	120	240	182	102	PA3	HR FK* 111	£275.40
6	160	150	10	342	70	134	268	233	125	PA4	HR FK* 112	£275.40
8	225	200	10	418	71	161	323	276	152	PA5	HR FK* 113	£307.80
10	280	250	10	520	114	210	405	444	226	PA7	HR FK* 114	£734.40
12	315	300	8	577	114	245	475	444	226	PA7	HR FK* 115	£734.40

Actuated valve prices are calculated by adding the above prices to the relevant manual valve prices, see page 64 for example.

FK BUTTERFLY VALVES

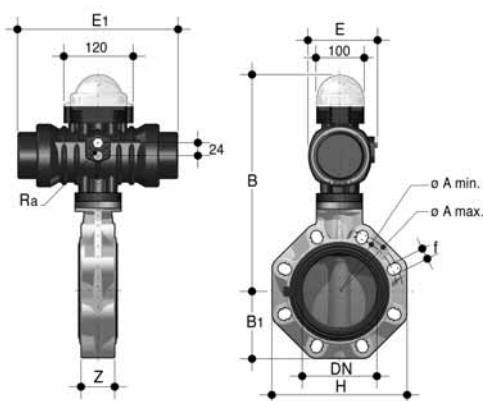

FK Pneumatically Actuated - Fail safe closed

G	d	DN	PN	B	Z	B ₁	H	E ₁	E	ACT	Product Code	List Price (£)
1 ^{1/2}	50	40	16	319	33	60	132	230	102	PA3/S	HS FK* 106	£279.29
2	63	50	16	325	43	70	147	230	102	PA3/S	HS FK* 107	£279.29
2 ^{1/2}	75	65	10	332	46	80	165	230	102	PA3/S	HS FK* 108	£279.29
3	90	80	10	380	49	93	185	304	125	PA4/S	HS FK* 109	£356.40
4	110	100	10	394	56	107	211	304	125	PA4/S	HS FK* 110	£356.40
5	140	125	10	414	64	120	240	479	177	PA6/S	HS FK* 111	£442.80
6	160	150	10	427	70	134	268	479	177	PA6/S	HS FK* 112	£442.80
8	225	200	10	523	71	161	323	479	177	PA6/S	HS FK* 113	£442.80
10	280	250	10	605	114	210	405	598	226	PA7/S	HS FK* 114	£1,013.40
12	315	300	8	662	114	245	475	598	226	PA7/S	HS FK* 115	£1,013.40

FK Pneumatically Actuated - Fail safe open

G	d	DN	PN	B	Z	B ₁	H	E ₁	E	ACT	Product Code	List Price (£)
1 ^{1/2}	50	40	16	319	33	60	132	230	102	PA3/S	HT FK* 106	£279.29
2	63	50	16	325	43	70	147	230	102	PA3/S	HT FK* 107	£279.29
2 ^{1/2}	75	65	10	332	46	80	165	230	102	PA3/S	HT FK* 108	£279.29
3	90	80	10	380	49	93	185	304	125	PA4/S	HT FK* 109	£356.40
4	110	100	10	394	56	107	211	304	125	PA4/S	HT FK* 110	£356.40
5	140	125	10	414	64	120	240	479	177	PA6/S	HT FK* 111	£442.80
6	160	150	10	427	70	134	268	479	177	PA6/S	HT FK* 112	£442.80
8	225	200	10	523	71	161	323	479	177	PA6/S	HT FK* 113	£442.80
10	280	250	10	605	114	210	405	598	226	PA7/S	HT FK* 114	£1,013.40
12	315	300	8	662	114	245	475	598	226	PA7/S	HT FK* 115	£1,013.40

FK Pneumatically Actuated - Double acting

G	d	DN	PN	B	Z	B ₁	H	E ₁	E	ACT	Product Code	List Price (£)
1 ^{1/2}	50	40	16	301	33	60	132	125	80	PA2	HU FK* 115	£279.29
2	63	50	16	307	43	70	147	125	80	PA2	HU FK* 116	£279.29
2 ^{1/2}	75	65	10	332	46	80	165	182	102	PA3	HU FK* 117	£279.29
3	90	80	10	346	49	93	185	182	102	PA3	HU FK* 118	£356.40
4	110	100	10	360	56	107	211	182	102	PA3	HU FK* 119	£356.40
5	140	125	10	380	64	120	240	182	102	PA3	HU FK* 120	£356.40
6	160	150	10	427	70	134	268	233	125	PA4	HU FK* 121	£356.40
8	225	200	10	503	71	161	323	276	152	PA5	HU FK* 122	£388.80
10	280	250	10	605	114	210	405	444	226	PA7	HU FK* 123	£815.40
12	315	300	8	662	114	245	475	444	226	PA7	HU FK* 124	£815.40

Actuated valve prices are calculated by adding the above prices to the relevant manual valve prices, see page 64 for example.

VM DIAPHRAGM VALVES

VM Pneumatic actuated - FSC

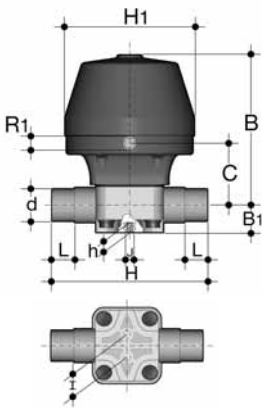

d	DN	PN	B	B ₁	C	H	h	H ₁	I	J	L	R ₁	g	Product Code	List Price (£)
Fail Safe Closed															
1/2 / 20	15	10	175	26	66	124	12	126	25	M6	16	1/4	1850	HP (V/U) M * * * *	£141.13
3/4 / 25	20	10	175	26	66	144	12	126	25	M6	19	1/4	1850	HP (V/U) M * * * *	£141.13
1 / 32	25	10	175	26	66	154	12	126	25	M6	23	1/4	1850	HP (V/U) M * * * *	£141.13
1 1/4 / 40	32	10	244	40	103	174	18	155	44.5	M8	27	1/4	4000	HP (V/U) M * * * *	£192.46
1 / 50	40	10	244	40	103	194	18	155	44.5	M8	32	1/4	4000	HP (V/U) M * * * *	£192.46
2 / 63	50	10	292	40	125	224	18	210	44.5	M8	39	1/4	6950	HP (V/U) M * * * *	£243.78
2 1/2 / 75	65	6	325	55	187	284	23	258	100	M12	51	1/4	15000	HP (V/U) M * * * *	£352.84
3 / 90	80	6	325	55	187	300	23	258	100	M12	51	1/4	15500	HP (V/U) M * * * *	£513.22
4 / 110	100	6	355	69	268	350	23	258	120	M12	-	1/4	25500	HP (V/U) M * * * *	£468.31

VM Pneumatic actuated - FSO/DA

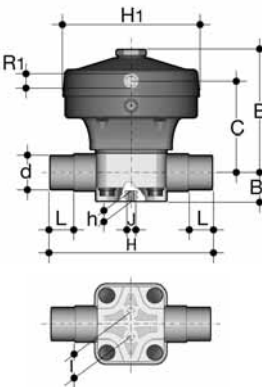

d	DN	PN	B	B ₁	C	H	h	H ₁	I	J	L	R ₁	g	Product Code	List Price (£)	Product Code	List Price (£)
Fail Safe Open																	
Double Acting																	
1/2 / 20	15	10	144	26	120	124	12	126	25	M6	16	1/4	1300	HQ (V/U) M * * * *	£57.74	HR (V/U) M * * * *	£57.74
3/4 / 25	20	10	144	26	120	144	12	126	25	M6	19	1/4	1300	HQ (V/U) M * * * *	£57.74	HR (V/U) M * * * *	£57.74
1 / 32	25	10	144	26	120	154	12	126	25	M6	23	1/4	1300	HQ (V/U) M * * * *	£57.74	HR (V/U) M * * * *	£57.74
1 1/4 / 40	32	10	201	40	133	174	18	155	44.5	M8	27	1/4	2800	HQ (V/U) M * * * *	£83.40	HR (V/U) M * * * *	£83.40
1 / 50	40	10	201	40	133	194	18	155	44.5	M8	32	1/4	2800	HQ (V/U) M * * * *	£83.40	HR (V/U) M * * * *	£83.40
2 / 63	50	10	237	40	156	224	18	210	44.5	M8	39	1/4	4600	HQ (V/U) M * * * *	£83.40	HR (V/U) M * * * *	£83.40
2 1/2 / 75	65	6	305	55	252	285	23	258	100	M12	44	1/4	12500	HQ (V/U) M * * * *	£83.40	HR (V/U) M * * * *	£83.40
3 / 90	80	6	305	55	252	300	23	258	100	M12	51	1/4	13000	HQ (V/U) M * * * *	£96.23	HR (V/U) M * * * *	£96.23
4 / 110	100	6	330	69	268	350	23	258	120	M12	-	1/4	22000	HQ (V/U) M * * * *	£96.23	HR (V/U) M * * * *	£96.23

VM Pneumatic actuated with limit switches - FSC

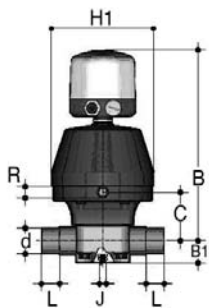

d	DN	PN	B	B ₁	C	H	h	H ₁	I	J	L	R ₁	g	Product Code	List Price (£)
Fail Safe Closed															
1/2 / 20	15	10	275	26	66	124	12	126	25	M6	16	1/4	1850	HS (V/U) M * * * *	£224.53
3/4 / 25	20	10	275	26	66	144	12	126	25	M6	19	1/4	1850	HS (V/U) M * * * *	£224.53
1 / 32	25	10	275	26	66	154	12	126	25	M6	23	1/4	1850	HS (V/U) M * * * *	£224.53
1 1/4 / 40	32	10	344	40	103	174	18	155	44.5	M8	27	1/4	4000	HS (V/U) M * * * *	£275.85
1 / 50	40	10	344	40	103	194	18	155	44.5	M8	32	1/4	4000	HS (V/U) M * * * *	£275.85
2 / 63	50	10	392	40	125	224	18	210	44.5	M8	39	1/4	6950	HS (V/U) M * * * *	£327.18
2 1/2 / 75	65	6	425	55	187	284	23	258	100	M12	51	1/4	15000	HS (V/U) M * * * *	£436.23
3 / 90	80	6	425	55	187	300	23	258	100	M12	51	1/4	15500	HS (V/U) M * * * *	£596.61
4 / 110	100	6	455	69	268	350	23	258	120	M12	-	1/4	25500	HS (V/U) M * * * *	£551.71

VM Pneumatic actuated with limit switches - FSO/DA

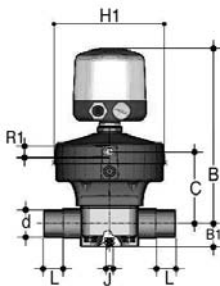

d	DN	PN	B	B ₁	C	H	h	H ₁	I	J	L	R ₁	g	Product Code	List Price (£)	Product Code	List Price (£)
Fail Safe Open																	
Double Acting																	
1/2 / 20	15	10	244	26	120	124	12	126	25	M6	16	1/4	1300	HT (V/U) M * * * *	£141.13	HU (V/U) M * * * *	£141.13
3/4 / 25	20	10	244	26	120	144	12	126	25	M6	19	1/4	1300	HT (V/U) M * * * *	£141.13	HU (V/U) M * * * *	£141.13
1 / 32	25	10	244	26	120	154	12	126	25	M6	23	1/4	1300	HT (V/U) M * * * *	£141.13	HU (V/U) M * * * *	£141.13
1 1/4 / 40	32	10	301	40	133	174	18	155	44.5	M8	27	1/4	2800	HT (V/U) M * * * *	£166.80	HU (V/U) M * * * *	£166.80
1 / 50	40	10	301	40	133	194	18	155	44.5	M8	32	1/4	2800	HT (V/U) M * * * *	£166.80	HU (V/U) M * * * *	£166.80
2 / 63	50	10	337	40	156	224	18	210	44.5	M8	39	1/4	4600	HT (V/U) M * * * *	£166.80	HU (V/U) M * * * *	£166.80
2 1/2 / 75	65	6	405	55	252	285	23	258	100	M12	44	1/4	12500	HT (V/U) M * * * *	£166.80	HU (V/U) M * * * *	£166.80
3 / 90	80	6	405	55	252	300	23	258	100	M12	51	1/4	13000	HT (V/U) M * * * *	£179.63	HU (V/U) M * * * *	£179.63
4 / 110	100	6	430	69	268	350	23	258	120	M12	-	1/4	22000	HT (V/U) M * * * *	£179.63	HU (V/U) M * * * *	£179.63

Actuated valve prices are calculated by adding the above prices to the relevant manual valve prices, see page 64 for example.

CM DIAPHRAGM VALVES

PVC-U with Metric series plain female ends

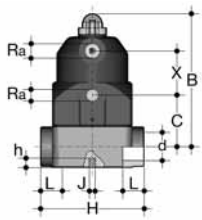

d	DN	PN	B	C	X	RA	L	H	h	J	g	Product Code	List Price (£)	Product Code	List Price (£)	Product Code	List Price (£)
16	12	6	98	38	34	1/8"	14	75	8	M5	340	H* CME 305	£67.41	H* CMF 305	£79.21	H* CMG 305	£85.67
20	15	6	98	38	34	1/8"	16	75	8	M5	340	H* CME 306	£71.47	H* CMF 306	£79.07	H* CMG 306	£86.49

HP = Fail safe closed
 HQ = Fail safe open
 HR = double acting

PVC-U with BSP parallel threaded female ends

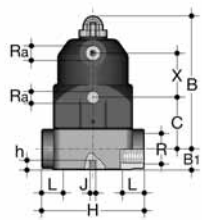

R	DN	PN	B	C	X	RA	L	H	h	J	g	Product Code	List Price (£)	Product Code	List Price (£)	Product Code	List Price (£)
3/8"	12	6	98	38	34	1/8"	14	75	8	M5	340	H* CME B01	£67.41	H* CMF B01	£79.21	H* CMG B01	£85.67
1/2"	15	6	98	38	34	1/8"	16	75	8	M5	340	H* CME B02	£71.46	H* CMF B02	£86.69	H* CMG B02	£87.26

HP = Fail safe closed
 HQ = Fail safe open
 HR = double acting

PVC-U with unionised BS series plain female ends

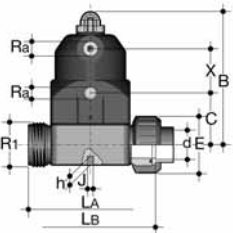

d	DN	PN	B	C	X	R1	X	RA	LA	LB	h	J	g	Product Code	List Price (£)	Product Code	List Price (£)	Product Code	List Price (£)
1/2"	15	6	98	38	41	1"	34	1/8"	90	96	8	M5	340	H* CUE 102	£92.25	H* CUF102	£100.90	H* CUG 102	£109.69

PVC-U with unionised Metric series plain female ends

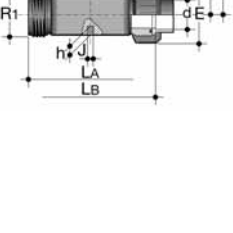

d	DN	PN	B	C	X	R1	X	RA	LA	LB	h	J	g	Product Code	List Price (£)	Product Code	List Price (£)	Product Code	List Price (£)
20	15	6	98	38	41	1"	34	1/8"	90	96	8	M5	340	H* CUE 306	£92.25	H* CUF 306	£100.90	H* CUG 306	£109.69

HP = Fail safe closed
 HQ = Fail safe open
 HR = double acting

PVC-U with unionised BSP parallel threaded female ends

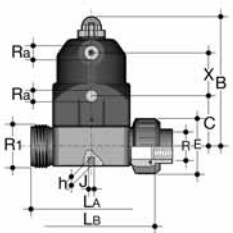

R	DN	PN	B	C	X	R1	X	RA	LA	LB	h	J	g	Product Code	List Price (£)	Product Code	List Price (£)	Product Code	List Price (£)
1/2"	15	6	98	38	41	1"	34	1/8"	90	96	8	M5	340	H* CUE B02	£94.94	H* CUFB02	£103.59	H* CUG B02	£112.38

HP = Fail safe closed
 HQ = Fail safe open
 HR = double acting

PVC-U with Metric series plain male ends

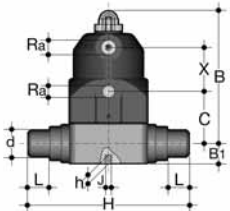

d	DN	PN	B	C	X	RA	L	H	h	J	g	Product Code	List Price (£)	Product Code	List Price (£)	Product Code	List Price (£)
20	15	6	98	38	34	1/8"	16	124	8	M5	340	H* CME 406	£71.47	H* CMF 406	£81.47	H* CMG 406	£90.06

HP = Fail safe closed
 HQ = Fail safe open
 HR = double acting

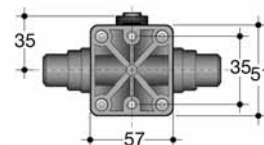
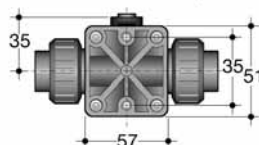
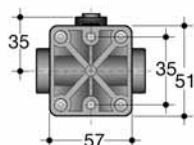

Prices for other materials are available on request.

VV ANGLE SEAT VALVES

PVC-U VV Pneumatic Fail Safe Closed

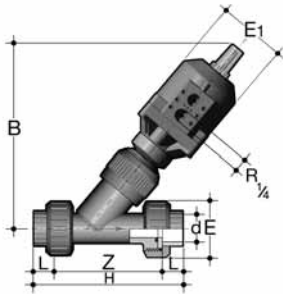

d	DN	PN	B	E	E	H	Z	L	g	Product Code	List Price (£)	d	Product Code	List Price (£)	
											Solvent Cement Socket - IMPERIAL		Solvent Cement Socket - METRIC		
1/2	20	10	200	80	55	135	103	16	975	HP VUE 102	£190.53	20	HP VUE 306	£190.53	
3/4	25	10	209	80	66	158	120	19	1110	HP VUE 103	£205.29	25	HP VUE 307	£205.29	
1	32	10	220	80	75	176	132	22	1305	HP VUE 104	£208.49	32	HP VUE 308	£208.49	
1 1/4	40	10	230	80	87	207	155	26	1660	HP VUE 105	£208.49	40	HP VUE 309	£208.49	
1 1/2	50	10	240	80	100	243	181	31	1990	HP VUE 106	£243.78	50	HP VUE 310	£243.78	
2	63	10	254	80	120	298	222	38	2830	HP VUE 107	£280.99	63	HP VUE 311	£280.99	

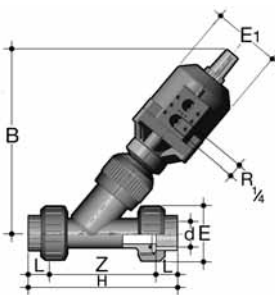

d	DN	PN	B	E	E	H	Z	L	g	Product Code	List Price (£)	
											Threaded Socket - BSP	
1/2	20	10	200	80	55	135	103	16	975	HP VUE B02	£193.74	
3/4	25	10	209	80	66	158	120	19	1110	HP VUE B03	£209.14	
1	32	10	220	80	75	176	132	22	1305	HP VUE B04	£214.27	
1 1/4	40	10	230	80	87	207	155	26	1660	HP VUE B05	£216.19	
1 1/2	50	10	240	80	100	243	181	31	1990	HP VUE B06	£255.32	
2	63	10	254	80	120	298	222	38	2830	HP VUE B07	£296.38	

PVC-U VV Pneumatic Fail Safe Open

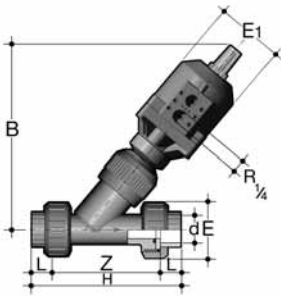

d	DN	PN	B	E	E	H	Z	L	g	Product Code	List Price (£)	d	Product Code	List Price (£)	
											Solvent Cement Socket - IMPERIAL		Solvent Cement Socket - METRIC		
1/2	20	10	200	80	55	135	103	16	975	HQ VUE 102	£190.53	20	HQ VUE 306	£190.53	
3/4	25	10	209	80	66	158	120	19	1110	HQ VUE 103	£205.29	25	HQ VUE 307	£205.29	
1	32	10	220	80	75	176	132	22	1305	HQ VUE 104	£208.49	32	HQ VUE 308	£208.49	
1 1/4	40	10	230	80	87	207	155	26	1660	HQ VUE 105	£208.49	40	HQ VUE 309	£208.49	
1 1/2	50	10	240	80	100	243	181	31	1990	HQ VUE 106	£243.78	50	HQ VUE 310	£243.78	
2	63	10	254	80	120	298	222	38	2830	HQ VUE 107	£280.99	63	HQ VUE 311	£280.99	

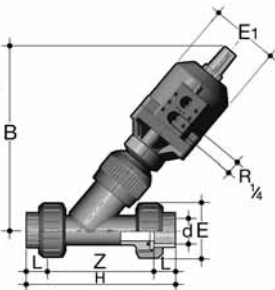

d	DN	PN	B	E	E	H	Z	L	g	Product Code	List Price (£)	
											Threaded Socket - BSP	
1/2	20	10	200	80	55	135	103	16	975	HQ VUE B02	£193.74	
3/4	25	10	209	80	66	158	120	19	1110	HQ VUE B03	£209.14	
1	32	10	220	80	75	176	132	22	1305	HQ VUE B04	£214.27	
1 1/4	40	10	230	80	87	207	155	26	1660	HQ VUE B05	£216.19	
1 1/2	50	10	240	80	100	243	181	31	1990	HQ VUE B06	£255.32	
2	63	10	254	80	120	298	222	38	2830	HQ VUE B07	£296.38	

VV ANGLE SEAT VALVES

PVC-U VV Pneumatic Double Acting

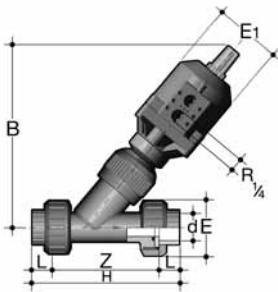

d	DN	PN	B	E	E	H	Z	L	g	Product Code	List Price (£)	d	Product Code	List Price (£)	
											Solvent Cement Socket - IMPERIAL		Solvent Cement Socket - METRIC		
1/2	20	10	200	80	55	135	103	16	975	HR VUE 102	£190.53	20	HR VUE 306	£190.53	
3/4	25	10	209	80	66	158	120	19	1110	HR VUE 103	£205.29	25	HR VUE 307	£205.29	
1	32	10	220	80	75	176	132	22	1305	HR VUE 104	£208.49	32	HR VUE 308	£208.49	
1 1/4	40	10	230	80	87	207	155	26	1660	HR VUE 105	£208.49	40	HR VUE 309	£208.49	
1 1/2	50	10	240	80	100	243	181	31	1990	HR VUE 106	£243.78	50	HR VUE 310	£243.78	
2	63	10	254	80	120	298	222	38	2830	HR VUE 107	£280.99	63	HR VUE 311	£280.99	

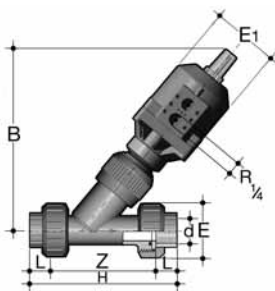

d	DN	PN	B	E	E	H	Z	L	g	Product Code	List Price (£)	
											Threaded Socket - BSP	
1/2	20	10	200	80	55	135	103	16	975	HR VUE B02	£193.74	
3/4	25	10	209	80	66	158	120	19	1110	HR VUE B03	£209.14	
1	32	10	220	80	75	176	132	22	1305	HR VUE B04	£214.27	
1 1/4	40	10	230	80	87	207	155	26	1660	HR VUE B05	£216.19	
1 1/2	50	10	240	80	100	243	181	31	1990	HR VUE B06	£255.32	
2	63	10	254	80	120	298	222	38	2830	HR VUE B07	£296.38	

SOLENOID VALVE PRODUCT CODE SELECTOR

Body Size	Seal Material/Operation	Valve Bore	Voltage	Size Ends
1 = Small Body - 2-Way 2 = Large Body - 2-Way 3 = Small Body - 3-Way 4 = Large Body - 3-Way	A = EPDM / Fail Safe Closed B = FPM / Fail Safe Closed D = EPDM / Fail Safe Open E = FPM / Fail Safe Open F = EPDM / Mixer G = FPM / Mixer H = EPDM / Diverter I = FPM / Diverter	04 = 4mm 06 = 6mm 08 = 8mm 10 = 10mm 15 = 15mm	A = 240v AC B = 110v AC C = 24v AC D = 110v DC E = 24v DC F = 12v DC	00 = 1/4" 01 = 3/8" 02 = 1/2" B0 = 1/4" BSP B1 = 3/8" BSP B2 = 1/2" BSP 03 = 10mm 04 = 12mm 05 = 16mm 06 = 20mm

2-WAY SOLENOID VALVES

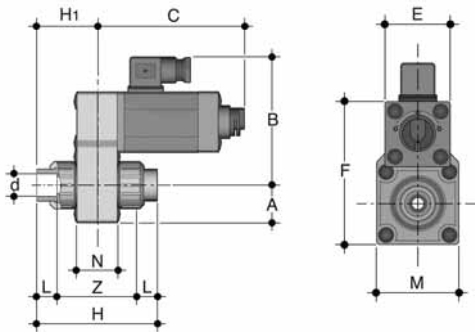

Solvent Cement Socket - Imperial

Body Size	Bore Size (DN) mm	Line Pressure Max (bar)	End Connection	KV	A	B	C	E	F	M	N	L	Z	H	H ₁	g	List Price (£)	List Price (£)
																	EPDM	FPM
Small	4	6	1/4"	6.5	22.5	105	89	39	87	50	30	12	60	84	42	430	£142.78	£157.19
Small	6	4	1/4"	11.0	22.5	105	89	39	87	50	30	12	60	84	42	430	£142.78	£157.19
Small	4	6	3/8"	6.5	22.5	105	89	39	87	50	30	14	60	88	44	430	£142.78	£157.19
Small	6	4	3/8"	11.0	22.5	105	89	39	87	50	30	14	60	88	44	430	£142.78	£157.19
Small	8	2	3/8"	13.5	22.5	105	89	39	87	50	30	14	60	88	44	430	£142.78	£157.19
Large	8	6	3/8"	18.3	32.5	121.5	109	52	113	65	35	14	71	99	49.5	1060	£211.97	£221.99
Large	10	4	3/8"	33.3	32.5	121.5	109	52	113	65	35	14	71	99	49.5	1060	£211.97	£221.99
Large	10	4	1/2"	33.3	32.5	121.5	109	52	113	65	35	16.5	71	104	52	1060	£211.97	£221.99
Large	15	2	1/2"	58.3	32.5	121.5	109	52	113	65	35	16.5	71	104	52	1060	£211.97	£221.99

Solvent Cement Socket - Metric

Body Size	Bore Size (DN) mm	Line Pressure Max (bar)	End Connection	KV	A	B	C	E	F	M	N	L	Z	H	H ₁	g	List Price (£)	List Price (£)
																	EPDM	FPM
Small	4	6	10mm	6.5	22.5	105	89	39	87	50	30	12	60	84	42	430	£142.78	£157.19
Small	6	4	12mm	11.0	22.5	105	89	39	87	50	30	12	60	84	42	430	£142.78	£157.19
Small	4	6	16mm	6.5	22.5	105	89	39	87	50	30	14	60	88	44	430	£142.78	£157.19
Small	6	4	16mm	11.0	22.5	105	89	39	87	50	30	14	60	88	44	430	£142.78	£157.19
Small	8	2	16mm	13.5	22.5	105	89	39	87	50	30	14	60	88	44	430	£142.78	£157.19
Large	8	6	16mm	18.3	32.5	121.5	109	52	113	65	35	14	71	99	49.5	1060	£211.97	£221.99
Large	10	4	16mm	33.3	32.5	121.5	109	52	113	65	35	14	71	99	49.5	1060	£211.97	£221.99
Large	10	4	20mm	33.3	32.5	121.5	109	52	113	65	35	16	71	103	51.5	1060	£211.97	£221.99
Large	15	2	20mm	58.3	32.5	121.5	109	52	113	65	35	16	71	103	51.5	1060	£211.97	£221.99

Threaded Socket - BSP

Body Size	Bore Size (DN) mm	Line Pressure Max (bar)	End Connection	KV	A	B	C	E	F	M	N	L	Z	H	H ₁	g	List Price (£)	List Price (£)
																	EPDM	FPM
Small	4	6	1/4"	6.5	22.5	105	89	39	87	50	30	11	63	85	42.5	430	£142.78	£157.19
Small	6	4	1/4"	11.0	22.5	105	89	39	87	50	30	11	63	85	42.5	430	£142.78	£157.19
Small	4	6	3/8"	6.5	22.5	105	89	39	87	50	30	11.4	63	85.8	42.9	430	£142.78	£157.19
Small	6	4	3/8"	11.0	22.5	105	89	39	87	50	30	11.4	63	85.8	42.9	430	£142.78	£157.19
Small	8	2	3/8"	13.5	22.5	105	89	39	87	50	30	11.4	63	85.8	42.9	430	£142.78	£157.19
Large	8	6	3/8"	18.3	32.5	121.5	109	52	113	65	35	11.4	74	96.8	48.4	1060	£211.97	£221.99
Large	10	4	3/8"	33.3	32.5	121.5	109	52	113	65	35	11.4	74	96.8	48.4	1060	£211.97	£221.99
Large	10	4	1/2"	33.3	32.5	121.5	109	52	113	65	35	15	75	105	52.5	1060	£211.97	£221.99
Large	15	2	1/2"	58.3	32.5	121.5	109	52	113	65	35	15	75	105	52.5	1060	£211.97	£221.99

3-WAY SOLENOID VALVES

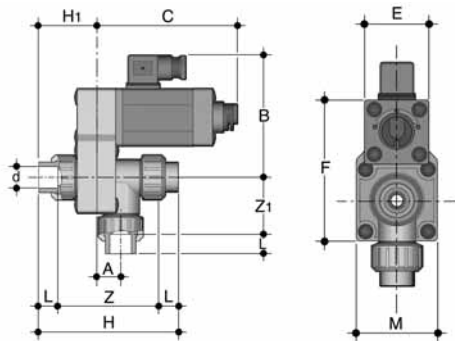

Solvent Cement Socket - Imperial

Body Size	Bore Size (DN) mm	Line Pressure Max (bar)	End Connection	KV	A	B	C	E	F	M	N	L	Z	H	H1	g	List Price (£)	List Price (£)
																	EPDM	FPM
Small	4	4	1/4"	6.8	14	105	89	39	87	50	12	69	36	93	42	455	£214.87	£221.99
Small	6	2.5	1/4"	11.6	14	105	89	39	87	50	12	69	36	93	42	455	£214.87	£221.99
Small	4	4	3/8"	6.8	14	105	89	39	87	50	14	69	36	97	44	455	£214.87	£221.99
Small	6	2.5	3/8"	11.6	14	105	89	39	87	50	14	69	36	97	44	455	£214.87	£221.99
Small	8	1.5	3/8"	13.8	14	105	89	39	87	50	14	69	36	97	44	455	£214.87	£221.99
Large	8	6	3/8"	20.0	22	121.5	109	52	113	65	14	89.5	46.5	117.5	49.5	1060	£295.16	£314.38
Large	10	4	3/8"	32.5	22	121.5	109	52	113	65	14	89.5	46.5	117.5	49.5	1060	£295.16	£314.38
Large	8	6	1/2"	20.0	22	121.5	109	52	113	65	16.5	89.5	46.5	122.5	52	1060	£295.16	£314.38
Large	10	4	1/2"	32.5	22	121.5	109	52	113	65	16.5	89.5	46.5	122.5	53	1060	£295.16	£314.38
Large	15	2	1/2"	60.3	22	121.5	109	52	113	65	16.5	89.5	46.5	122.5	54	1060	£295.16	£314.38

Solvent Cement Socket - Metric

Body Size	Bore Size (DN) mm	Line Pressure Max (bar)	End Connection	KV	A	B	C	E	F	M	N	L	Z	H	H1	g	List Price (£)	List Price (£)
																	EPDM	FPM
Small	4	4	10mm	6.8	14	105	89	39	87	50	12	69	36	93	42	455	£214.87	£221.99
Small	6	2.5	10mm	11.6	14	105	89	39	87	50	12	69	36	93	42	455	£214.87	£221.99
Small	8	1.5	12mm	13.8	14	105	89	39	87	50	14	69	36	93	42	455	£214.87	£221.99
Small	4	4	16mm	6.8	14	105	89	39	87	50	14	69	36	97	44	455	£214.87	£221.99
Small	6	2.5	16mm	11.6	14	105	89	39	87	50	14	69	36	97	44	455	£214.87	£221.99
Small	8	1.5	16mm	13.8	14	105	89	39	87	50	14	69	36	97	44	455	£214.87	£221.99
Large	8	6	16mm	20.0	22	121.5	109	52	113	65	14	89.5	46.5	117.5	49.5	1060	£295.16	£314.38
Large	10	4	16mm	32.5	22	121.5	109	52	113	65	14	89.5	46.5	117.6	49.6	1060	£295.16	£314.38
Large	8	6	20mm	20.0	22	121.5	109	52	113	65	16	89.5	46.5	121.5	51.5	1060	£295.16	£314.38
Large	10	4	20mm	32.5	22	121.5	109	52	113	65	16	89.5	46.5	121.6	51.5	1060	£295.16	£314.38
Large	15	2	20mm	60.3	22	121.5	109	52	113	65	16	89.5	46.5	121.7	51.5	1060	£295.16	£314.38

Threaded Socket - BSP

Body Size	Bore Size (DN) mm	Line Pressure Max (bar)	End Connection	KV	A	B	C	E	F	M	N	L	Z	H	H1	g	List Price (£)	List Price (£)
																	EPDM	FPM
Small	4	4	1/4"	6.8	14	105	89	39	87	50	11	72	37.5	94	42.5	455	£214.87	£221.99
Small	6	2.5	1/4"	11.6	14	105	89	39	87	50	11	72	37.5	94	42.5	455	£214.87	£221.99
Small	4	4	3/8"	6.8	14	105	89	39	87	50	11.4	72	37.5	94.8	42.9	455	£214.87	£221.99
Small	6	2.5	3/8"	11.6	14	105	89	39	87	50	11.4	72	37.5	94.8	42.9	455	£214.87	£221.99
Small	8	1.5	3/8"	13.8	14	105	89	39	87	50	11.4	72	37.5	94.8	42.9	455	£214.87	£221.99
Large	8	6	3/8"	20.0	22	121.5	109	52	113	65	11.4	92.5	48	115.3	48.4	1060	£295.16	£314.38
Large	10	4	3/8"	32.5	22	121.5	109	52	113	65	11.4	92.5	48	115.3	48.4	1060	£295.16	£314.38
Large	8	6	1/2"	20.0	22	121.5	109	52	113	65	15	93.5	48.5	123.5	52.5	1060	£295.16	£314.38
Large	10	4	1/2"	32.5	22	121.5	109	52	113	65	15	93.5	48.5	123.5	52.5	1060	£295.16	£314.38
Large	15	2	1/2"	60.3	22	121.5	109	52	113	65	15	93.5	48.5	123.5	52.5	1060	£295.16	£314.38

VKD & TKD DUAL BLOCK ACCESSORIES

PowerQuick CP

Actuation kit for VKD & TKD



d	ISO	Square	Product Code	List Price (£)
3/8"/16	F03-04*	11	KT PQC PEF	£30.08
1/2"/20	F03-04*	11	KT PQC PEF	£30.08
3/4"/25	F03-05*	11	KT PQC PGG	£31.90
3/4"/25	F04	11	KT PQC PG4	£31.90
1"/32	F03-05*	11	KT PQC PHH	£31.90
1"/32	F04	11	KT PQC PH4	£31.90
1 1/4"/40	F05-07*	14	KT PQC PI I	£36.46
1 1/2"/50	F05-07*	14	KT PQC PJJ	£36.46
2"/63	F05-07*	14	KT PQC PLL	£38.74

* For limit switch box MSKD type

MSKD - Limit Switch Box

Limit switch box MS type for manual valve, to be installed with Actuation Kit for VKD & TKD



d	ISO	Square	Product Code	List Price (£)
Electromechanical				
3/8"/16 - 1"/32	F03-05	11	KT MSK D1	£94.40
1 1/4"/40 - 2"/63	F03-05	14	KT MSK D2	£94.40
Inductive 2 wires				
3/8"/16 - 1"/32	F03-05	11	KT MSK D1I	£351.63
1 1/4"/40 - 2"/63	F03-05	14	KT MSK D2I	£351.63
Inductive Namur				
3/8"/16 - 1"/32	F03-05	11	KT MSK D1N	£382.35
1 1/4"/40 - 2"/63	F03-05	14	KT MSK D2N	£382.35

SKD - Stem Extension Kit

Extension Kit for VKD & TKD (Pipe not included)



d	Product Code	List Price (£)
3/8"/16 (d25 pipe required)	KT SKD EF	£29.19
1/2"/20 (d25 pipe required)	KT SKD EF	£29.19
3/4"/25 (d25 pipe required)	KT SKD GG	£29.82
1"/32 (d25 pipe required)	KT SKD HH	£30.61
1 1/4"/40 (d32 pipe required)	KT SKD II	£30.92
1 1/2"/50 (d32 pipe required)	KT SKD JJ	£32.18
2"/63 (d32 pipe required)	KT SKD LL	£35.50

LTKD (90° - 180°) - Rotational stroke limiter 90° or 180° for use with TKD



90°

d	Product Code	List Price (£)
16-20	LTKD 9020	£14.64
25-32	LTKD 9032	£16.40
40-50	LTKD 9050	£19.60
63	LTKD 9063	£23.40

180°

d	Product Code	List Price (£)
16-20	LTKD 8020	£14.64
25-32	LTKD 8032	£16.40
40-50	LTKD 8050	£19.60
63	LTKD 8063	£23.40

SHKD - Handle Block Kit

Handle block kit to be installed on the handle of the VKD & TKD valve (handle not included)



d	Product Code	List Price (£)
3/8"/16	KT SHKD EF	£13.41
1/2"/20	KT SHKD EF	£13.41
3/4"/25	KT SHKD GH	£14.99
1"/32	KT SHKD GH	£14.99
1 1/4"/40	KT SHKD IJ	£17.35
1 1/2"/50	KT SHKD IJ	£17.35
2"/63	KT SHKD LL	£18.62

PMKD - Distance Plate

Distance plate for wall mounting installations



d	Product Code	List Price (£)
3/8"/16 - 1"/32	PM KD 01	£7.10
1 1/4"/40 - 2"/63	PM KD 02	£7.73

Distance Plate Kit

Kit comprised by distant plate PMKD, screws, brass inserts for wall mounting installations



d	Product Code	List Price (£)
3/8"/16 - 1"/32	KT PMKD 01	£8.83
1 1/4"/40 - 2"/63	KT PMKD 02	£9.31

Fastening Stainless Steel Inserts

Stainless steel threaded inserts to be installed under the valve for bracketing and support (20 pieces)

d	Threads	Product Code	List Price (£)
3/8"/16 - 1"/32	M4	SI NSM 04X	£68.63
1 1/4"/40 - 2"/63	M6	SI NSM 06X	£75.89

Fastening Brass Inserts

Brass threaded inserts to be installed under the valve for bracketing and support (20 pieces)

d	Threads	Product Code	List Price (£)
3/8"/16 - 1"/32	M4	SI NSM 040	£12.42
1 1/4"/40 - 2"/63	M6	SI NSM 060	£14.97

ACCESSORIES

FOR VKD BALL AND FK BUTTERFLY VALVES

Electric Actuators



Type	Voltage	Code	List price
------	---------	------	------------

Electric Actuator - Standard

EA2	100 to 240vAC	HZ EA2 001	£275.94
EA2	24vAC/DC	HZ EA2 002	£275.94
EA3	100 to 240vAC	HZ EA3 001	£394.74
EA3	24vAC/DC	HZ EA3 002	£394.74
EA5	100 to 240vAC	HZ EA5 001	£670.32
EA5	24vAC/DC	HZ EA5 002	£670.32
EA6	100 to 240vAC	HZ EA6 001	£818.21
EA6	24vAC/DC	HZ EA6 002	£818.21
EA8	100 to 240vAC	HZ EA8 001	£1,134.48
EA8	24vAC/DC	HZ EA8 002	£1,134.48

Electric Actuator - Fail Safe Version

EA2	100 to 240vAC	HZ EB2 001	£426.69
EA2	24vAC/DC	HZ EB2 002	£426.69
EA3	100 to 240vAC	HZ EB3 001	£551.34
EA3	24vAC/DC	HZ EB3 002	£551.34
EA5	100 to 240vAC	HZ EB5 001	£892.70
EA5	24vAC/DC	HZ EB5 002	£892.70
EA6	100 to 240vAC	HZ EB6 001	£1,040.04
EA6	24vAC/DC	HZ EB6 002	£1,040.04
EA8	100 to 240vAC	HZ EB8 001	£1,356.41
EA8	24vAC/DC	HZ EB8 002	£1,356.41

Electric Actuator - 4 to 20mA Positioning

EA2	100 to 240vAC	HZ EM2 001	£473.58
EA2	24vAC/DC	HZ EM2 002	£473.58
EA3	100 to 240vAC	HZ EM3 001	£569.70
EA3	24vAC/DC	HZ EM3 002	£569.70
EA5	100 to 240vAC	HZ EM5 001	£1,042.46
EA5	24vAC/DC	HZ EM5 002	£1,042.46
EA6	100 to 240vAC	HZ EM6 001	£1,190.34
EA6	24vAC/DC	HZ EM6 002	£1,190.34

Limit switch setting tool for Electric Actuators EA2 to EA8

HZ LST 001	£6.42
------------	-------

Pneumatic Actuators



Type	Code	List price
------	------	------------

Pneumatic Actuator - Spring Return

PA1	HZ PA1 OSR	£83.40
PA2	HZ PA2 OSR	£134.72
PA3	HZ PA3 OSR	£179.63
PA4	HZ PA4 OSR	£263.02
PA6	HZ PA6 OSR	£538.88
PA7	HZ PA7 OSR	£1,013.61

Pneumatic Actuator - Double Acting

PA1	HZ PA1 ODA	£76.98
PA2	HZ PA2 ODA	£121.89
PA3	HZ PA3 ODA	£153.97
PA4	HZ PA4 ODA	£218.12
PA5	HZ PA5 ODA	£314.34
PA7	HZ PA7 ODA	£769.82

Pneumatic Actuators



Switch box with 2 auxillary limit switches to suit PA1 to PA7 Pneumatic Actuator

Code	List price
------	------------

With Mechanical limit switches

HZ SB2 100	£109.06
------------	---------

With intrinsically safe proximity switches

HZ SB3 100	£290.00
------------	---------

Switch Box mounting plate for PA2 to PA7

HZ MP4 100	£9.85
------------	-------

Pilot Solenoid Valve 3/2 - 5/2 to suit Pneumatic actuators (Namur mount)

Voltage	Code	List price
240vAC	HZ PS1 240	£93.66
110vAC	HZ PS1 110	£93.66
24vAC	HZ PS1 24A	£93.66
24vDC	HZ PS1 24D	£93.66

For VM Diaphragm Valves



Switch box with 2 auxillary switches to suit VM Diaphragm Valve

Valve Size	Code	List price
------------	------	------------

FSC

³ / ₈ " - d16	HZ SB5 100	£109.06
¹ / ₂ " - d20	HZ SB5 100	£109.06
³ / ₄ " - d25	HZ SB5 100	£109.06
1" - d32	HZ SB5 100	£109.06
¹ / ₄ " - d40	HZ SB5 100	£109.06
¹ / ₂ " - d50	HZ SB5 100	£109.06
2" - d63	HZ SB6 100	£109.06
² / ₁ " - d75	HZ SB6 100	£109.06
3" - d90	HZ SB6 100	£109.06
4" - d110	HZ SB6 100	£109.06

FSO / DA

³ / ₈ " - d16	HZ SB7 100	£109.06
¹ / ₂ " - d20	HZ SB7 100	£109.06
³ / ₄ " - d25	HZ SB7 100	£109.06
1" - d32	HZ SB7 100	£109.06
¹ / ₄ " - d40	HZ SB7 100	£109.06
¹ / ₂ " - d50	HZ SB7 100	£109.06
2" - d63	HZ SB7 100	£109.06
² / ₁ " - d75	HZ SB7 100	£109.06
3" - d90	HZ SB7 100	£109.06
4" - d110	HZ SB7 100	£109.06

Pilot Solenoid Valve 3/2 to suit Pneumatic actuators (Direct mount)

240vAC	HZ PS2 240	£51.32
110vAC	HZ PS2 110	£51.32
24vAC	HZ PS2 24A	£51.32
24vDC	HZ PS2 24D	£51.32

For Double Acting - 2 off pilot valves are required for correct operation.

The following optional extras are available on request to special order.

Please contact our Valve and Flow control Department to obtain price and availability.

- Visual Position Indicator
- Combined Stroke Limiter, Position Indicator & Manual Override
- Stroke Limiter
- Switch Box with 2 inductive switches
- Combined Stroke Limiter & Position Indicator
- Pneumatic Positioner

price list



 **Durapipe**
Valves and Flow Control Solutions



price list



Durapipe FIP Manual and Actuated Valves

Complete flow control solutions



At the forefront of thermoplastic pipework technology for over half a century, the Durapipe range is widely used in industrial and building services markets around the world.

Like Durapipe UK, FIP is a member of the Aliaxis group of companies with an international reputation for quality of design and manufacturing dating back to 1954 when they produced the first ever PVC-U ball valve.

This brochure introduces the comprehensive Durapipe FIP range of valves and actuation, the culmination of a highly successful long-term business relationship.

A wide product range for an extensive range of applications:

- PVC-U** Excellent resistance to chemicals and non-toxic – ideal for most general purpose applications
- ABS** Wide temperature range, ideal for chilled, condensate and cold water systems
- Corzan (PVC-C)** High temperature performance and excellent chemical resistance – ideal for conveying hot chemicals
- Polypropylene (PP)** Tough and durable, resists many concentrated acids, alkalis and organic solvents - ideal for many industrial applications, particularly in the chemical industries



Durapipe FIP expertise and experience:

- System sizing advice
- Valve and actuation selection advice
- Full quality assurance to BS EN ISO 9001
- Complete actuation traceability - each item carries an individual serial number

Durapipe FIP service:

- Most valves are available within 48 hours of ordering

Fully complies with PED

The European Parliament Pressure Equipment Directive 97/23/EC requires that pressure equipment should meet essential safety requirements (including design, manufacture and testing) and must satisfy an appropriate conformity procedure.

Durapipe FIP fully complies with these requirements and operates within a full Quality Assurance system to ISO 9001.

VKD Valve

The VKD ball valve with Dual Block® technology is developed by FIP. The VKD provides an advanced standard in valve design that stands up to the most severe industrial application requirements.



TKD Valve

Durapipe FIP extend the Dual Block® valve family introducing a new version of three way ball valve. Building on the popular features of the market leading VKD, the TKD 3-way valve incorporates optional extension handle & rotational stroke limiters that limit the movement to 90° or 180°.



CONTENTS

Manual Valves

Valve product code selector.....	4
How to use this catalogue.....	5

Valve Type.....	Series	Page(s)
-----------------	--------------	---------

PVC-U - Imperial/Metric

Double union ball valves.....VKD.....	8-10
2-way ball valves.....VKD.....	11
Double union ball valves.....VX.....	12
Double union ball valves.....VE.....	13
3-way ball valves.....TKD.....	14-15
Ball valve accessories.....	16
Butterfly valves.....FK.....	17-18
Butterfly valves.....FE.....	19
Diaphragm valves.....VM.....	20-22
Compact diaphragm valves.....CM.....	23
Mini diaphragm valves.....VM.....	24
Mini diaphragm cocks.....RM.....	24
Foot valves.....VZ.....	24
Air release valves.....VA.....	25
Ball check valves.....SR.....	25
Angle seat valves.....VR.....	26-27
Sediment strainers.....RV.....	28-30
Angle seat valves.....VV.....	31
Pressure relief valves.....PR.....	32

ABS - Imperial/Metric

Double union ball valves.....VKD.....	34-35
2-way ball valves.....VKD.....	36
Ball valves.....EV.....	36
3-way ball valves.....TKD.....	37
Butterfly valves.....FK.....	38-39
Diaphragm valves.....VM.....	40
Air release valves.....VA.....	41
Ball check valves.....SR.....	41
Sediment strainers.....RV.....	42
Pressure relief valves.....PR.....	42

Polypropylene - Imperial/Metric

Double union ball valves.....VKD.....	44-45
2-way ball valves.....VKD.....	46
3-way ball valves.....TKD.....	46-47
Ball valve accessories.....	47
Butterfly valves.....FK.....	48-49
Diaphragm valves.....VM.....	50-51
Ball check valves.....SR.....	52
Angle seat valves.....VR.....	52
Sediment strainers.....RV.....	53
Pressure relief valves.....PR.....	54

Corzan - Metric

Double union ball valves.....VKD.....	56-57
2-way ball valves.....VKD.....	57
3-way ball valves.....TKD.....	58
Ball valve accessories.....	58
Butterfly valves.....FK.....	59-60
Diaphragm valves.....VM.....	61
Ball check valves.....SR.....	62
Sediment strainers.....UV.....	62
Pressure relief valves.....PR.....	62

Actuated Valves

How to use this catalogue.....	64
--------------------------------	----

Valve Type.....	Series	Page(s)
-----------------	--------------	---------

Double union ball valves.....VKD.....	65-67
3-way ball valves.....TKD.....	68
Butterfly valves.....FK.....	69-71
Diaphragm valves.....VM.....	72
Compact diaphragm valves.....CM.....	73
Angle seat valves.....VV.....	74-75
Solenoid valve product code selector.....	76
2-way solenoid valves.....S1/S2.....	77
3-way solenoid valves.....S1/S2.....	78
VKD & TKD dual block accessories.....	79-80

Flowmeters

Flowmeters promotional page.....	81
Accessories.....	81
PVC-U Imperial.....	82-83
PVC-U Metric.....	84-85
ABS Imperial.....	86-87
ABS Metric.....	88-89
FlowX3 promotional page.....	90
Conditions of sale.....	91

VALVE PRODUCT CODE SELECTOR

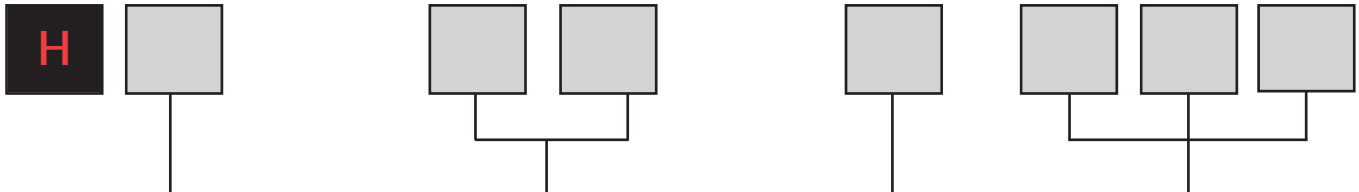

Operation/Actuation	Valve Type	Body Seal Material	Size/Ends	
0 = Standard Manual Valve	Ball Valves	ABS Options	Plain Socket	Plain Spigot
Electric Actuation	DK = Double Union Ball Valve	A = ABS / EPDM	101 = 3/8"	201 = 3/8"
1 = 100 - 240v AC	SK = 2-Way Single Union Ball Valve	B = ABS / FPM	102 = 1/2"	202 = 1/2"
2 = 24v AC/DC	VX = Compact Double Union Ball Valve	C = ABS / PTFE	103 = 3/4"	203 = 3/4"
3 = 100 - 240v AC - Fail Safe Closed	VE = Economy Double Union Ball Valve	PVC-U Options	104 = 1"	204 = 1"
4 = 24v AC/DC - Fail Safe Closed	EV = Economy Double Union Ball Valve	E = PVC-U / EPDM	105 = 1 1/4"	205 = 1 1/4"
5 = 100 - 240v AC - Fail Safe Open	LT = TKD 3-way L Port Ball Valve	F = PVC-U / FPM	106 = 1 1/2"	206 = 1 1/2"
6 = 24v AC/DC - Fail Safe Open	TT = TKD 3-way T Port Ball Valve	G = PVC-U / PTFE	107 = 2"	207 = 2"
7 = 100-240v AC - Positioning (4-20mm)	MT/ML/MC = Multiport Ball Valve - 3 positions	PVC-C Options	108 = 2 1/2"	208 = 2 1/2"
8 = 24v AC/DC - Positioning (4-20mm)	Butterfly Valves	J = PVC-C / EPDM	109 = 3"	209 = 3"
Pneumatic Actuation	FK = Butterfly Valve	K = PVC-C / FPM	110 = 4"	210 = 4"
P = Pneu, Fail Safe Closed	FE = Economy Butterfly Valve	L = PVC-C / PTFE	111 = 5"	211 = 5"
Q = Pneu, Fail Safe Open	Diaphragm Valves	PP Options	112 = 6"	212 = 6"
R = Pneu, Double Acting	VM = Diaphragm Valve	N = PP / EPDM	113 = 8"	213 = 8"
S = Pneu, Fail Safe Closed + Switch Box	UM = Diaphragm Valve (Union ended)	P = PP / FPM	114 = 10"	214 = 10"
T = Pneu, Fail Safe Open + Switch Box	CM = Compact Diaphragm Valve	Q = PP / PTFE	115 = 12"	215 = 12"
U = Pneu, Double Acting + Switch Box	CU = Compact Diaphragm Valve (Union ended)	PVDF Options	Plain Socket	Plain Spigot
Other	RM = Mini Diaphragm and Cock	S = PVDF / EPDM	304 = 12mm	404 = 12mm
V = Gearbox Operated	Check Valves	T = PVDF / FPM	305 = 16mm	405 = 16mm
	VZ = Check Valve, Piston Type	U = PVDF / PTFE	306 = 20mm	406 = 20mm
	SR = Ball Check Valve		307 = 25mm	407 = 25mm
	VR = Angle Seat Check Valve		308 = 32mm	408 = 32mm
	UR = Angle Seat Check Valve (Union ended)		309 = 40mm	409 = 40mm
	Sediment Strainers		310 = 50mm	410 = 50mm
	RV = Sediment Strainer		311 = 63mm	411 = 63mm
	UV = Sediment Strainer (Union ended)		312 = 75mm	412 = 75mm
	RT = Sediment Strainer - Transparent		313 = 90mm	413 = 90mm
	UT = Sediment Strainer - Transparent (Union ended)		314 = 110mm	414 = 110mm
	Angle Seat Valves		315 = 125mm	415 = 125mm
	VV = Angle Seat Valve		317 = 160mm	417 = 160mm
	VU = Angle Seat Valve (Union ended)		319 = 225mm	419 = 225mm
	Other Valves		320 = 250mm	420 = 250mm
	VA = Air Release Valve		323 = 315mm	423 = 315mm
	PR = Pressure Relief Valve			

For different end options, change the first digit of size/end code (**imperial only**) to the following:

B = Threaded BSP	H = Hosetails
F = Flanged BS4504, PN10	D = Flanged BS10, Table D
N = Threaded NPT	E = Flanged BS10, Table E
A = ASTM	X = Flanged ANSI 150

For different end options, change the first digit of size/end code (**metric**) to the following:

M = PE. Long Male Spigot Ended, for Butt Fusion
--

HOW TO USE THIS CATALOGUE - MANUAL VALVES

Durapipe FIP valves are coded in a simple and logical manner, each box containing information about the valve required:

Example:



- H** = Prefixes all valve orders
- O** = Type of operation/actuator
In this example: Manually operated
- D K** = Type of valve
In this example: VKD Double union ball
- B** = Body and seals details
In this example: ABS body with FPM seals
- 1 0 6** = Valve size
In this example: to suit a pipe of 1 1/2" nominal bore

To order, simply select the appropriate combination from page 4 or page 76 in this catalogue.

Valve type	Actuation available	
	Electrical	Pneumatic
Butterfly	*	*
Diaphragm		*
Ball	*	*
Angle seat		*

We offer:

- System design and sizing advice
- Valve and actuation selection advice
- Full quality assurance to BS EN ISO 9001
- Complete actuation traceability - each item carries an individual serial number

There are some 5000 line items in our Valve Actuation range. Please ask for full details.

Valve overview



Ball Valve

Durapipe UK offer a wide range of manual valves to suit a range of industrial applications and requirements. They are designed in a variety of materials to fully complement the pipe and fittings ranges, offering fully matched pipework systems.

Full technical support on these market leading flow control solutions is provided by our dedicated, in-house Valve Department and can be contacted on 01543 272424.



3-way Ball Valve



Angle Seat Valve



Diaphragm Valve



Sediment Strainer



Butterfly Valve

Valve actuation

Durapipe UK also offer an unrivalled range of electric and pneumatic actuated valve solutions. These are assembled in-house by our dedicated valve team and can usually be delivered to site within 48 hours. For further information please refer to Actuated Valves section, page 63.



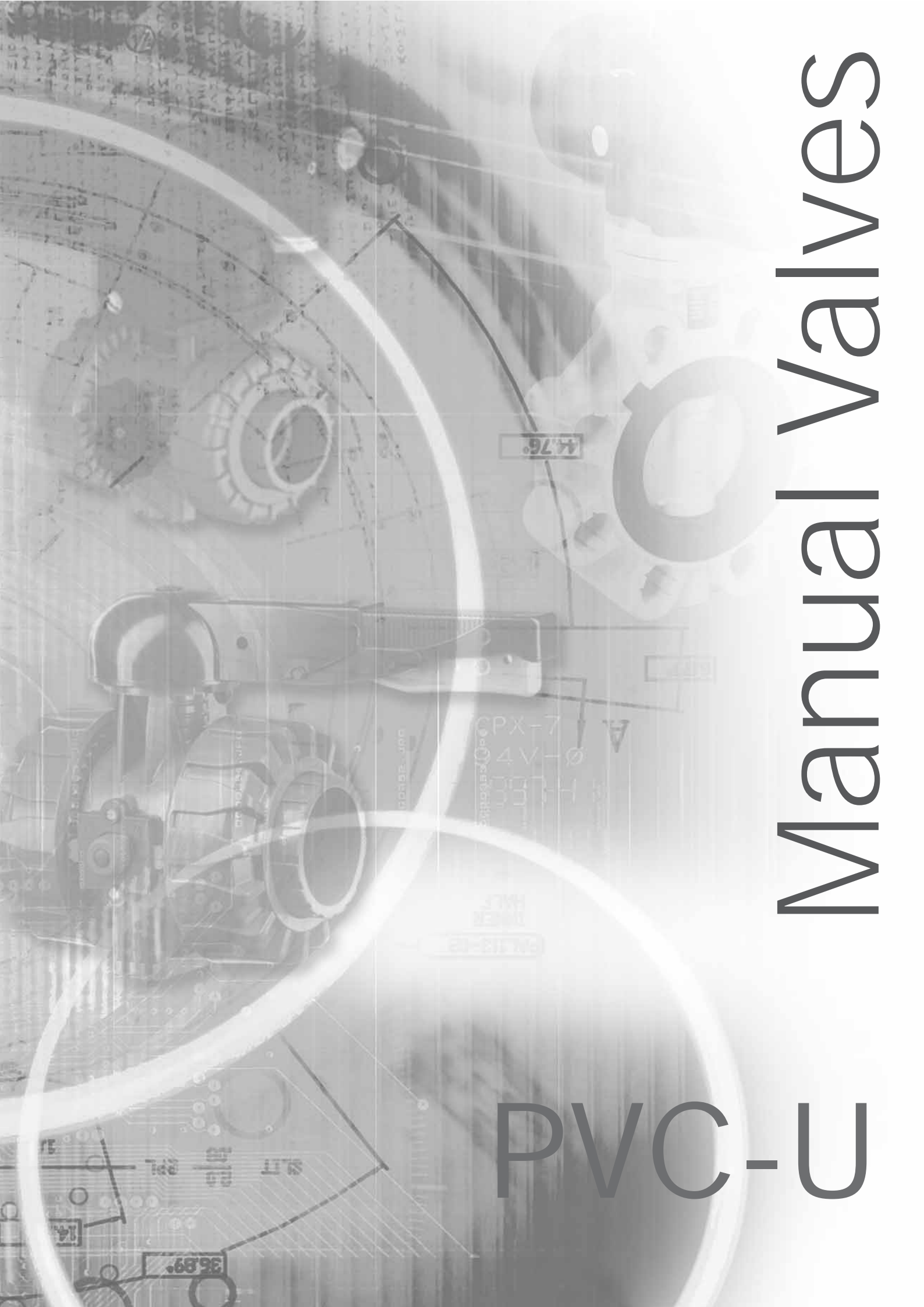

PVC-U

Manual Valves

VKD DOUBLE UNION BALL VALVES ($\frac{3}{8}$ "/d16 to 2"/d63)

with BS series plain female ends - Standard valve

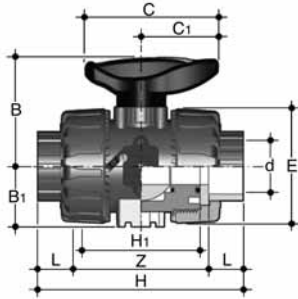

d	DN	PN	L	Z	H	H ₁	E	B	B ₁	C	C ₁	g	Product Code	List Price (£)	Product Code	List Price (£)
													EPDM		FPM	
$\frac{3}{8}$	10	16	14.5	74	103	65	54	54	29	67	40	215	HO DKE 101	£37.83	HO DKF 101	£46.40
$\frac{1}{2}$	15	16	16.5	70	103	65	54	54	29	67	40	205	HO DKE 102	£39.38	HO DKF 102	£47.01
$\frac{3}{4}$	20	16	19	77	115	70	65	65	34.5	85	49	330	HO DKE 103	£46.40	HO DKF 103	£55.74
1	25	16	22.5	83	128	78	73	69.5	39	85	49	438	HO DKE 104	£56.06	HO DKF 104	£69.59
$1\frac{1}{4}$	32	16	26	94	146	88	86	82.5	46	108	64	693	HO DKE 105	£71.31	HO DKF 105	£84.38
$1\frac{1}{2}$	40	16	30	104	164	93	98	89	52	108	64	925	HO DKE 106	£92.16	HO DKF 106	£110.69
2	50	16	36	127	199	111	122	108	62	134	76	1577	HO DKE 107	£116.93	HO DKF 107	£151.78

with BS series plain female ends - Valve, with lockable handle

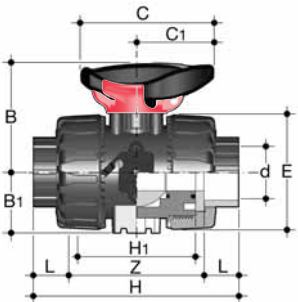

d	DN	PN	L	Z	H	H ₁	E	B	B ₁	C	C ₁	g	Product Code	List Price (£)	Product Code	List Price (£)
													EPDM		FPM	
$\frac{3}{8}$	10	16	14.5	74	103	65	54	54	29	67	40	215	HO DLE 101	£52.32	HO DLF 101	£60.88
$\frac{1}{2}$	15	16	16.5	70	103	65	54	54	29	67	40	205	HO DLE 102	£53.87	HO DLF 102	£61.50
$\frac{3}{4}$	20	16	19	77	115	70	65	65	34.5	85	49	330	HO DLE 103	£62.58	HO DLF 103	£71.93
1	25	16	22.5	83	128	78	73	69.5	39	85	49	438	HO DLE 104	£72.25	HO DLF 104	£85.78
$1\frac{1}{4}$	32	16	26	94	146	88	86	82.5	46	108	64	693	HO DLE 105	£90.06	HO DLF 105	£103.12
$1\frac{1}{2}$	40	16	30	104	164	93	98	89	52	108	64	925	HO DLE 106	£110.90	HO DLF 106	£129.43
2	50	16	36	127	199	111	122	108	62	134	76	1577	HO DLE 107	£137.04	HO DLF 107	£171.89

with Metric series plain female ends - Standard valve

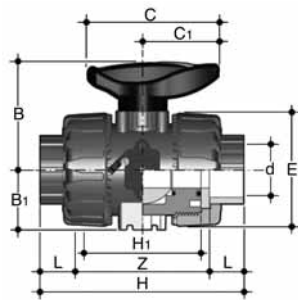

d	DN	PN	L	Z	H	H ₁	E	B	B ₁	C	C ₁	g	Product Code	List Price (£)	Product Code	List Price (£)
													EPDM		FPM	
16	10	16	14	75	103	65	54	54	29	67	40	215	HO DKE 305	£37.83	HO DKF 305	£46.42
20	15	16	16	71	103	65	54	54	29	67	40	205	HO DKE 306	£39.44	HO DKF 306	£47.00
25	20	16	19	77	115	70	65	65	34.5	85	49	330	HO DKE 307	£46.42	HO DKF 307	£55.73
32	25	16	22	84	128	78	73	69.5	39	85	49	438	HO DKE 308	£56.02	HO DKF 308	£56.02
40	32	16	26	94	146	88	86	82.5	46	108	64	693	HO DKE 309	£71.30	HO DKF 309	£84.39
50	40	16	31	102	164	93	98	89	52	108	64	925	HO DKE 310	£92.11	HO DKF 310	£110.73
63	50	16	38	123	199	111	122	108	62	134	76	1577	HO DKE 311	£116.98	HO DKF 311	£151.76

with Metric series plain female ends - Valve, with lockable handle

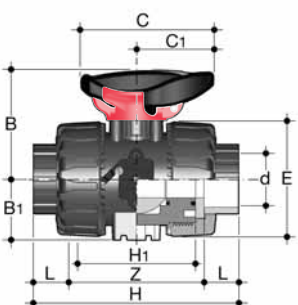

d	DN	PN	L	Z	H	H ₁	E	B	B ₁	C	C ₁	g	Product Code	List Price (£)	Product Code	List Price (£)
													EPDM		FPM	
16	10	16	14	75	103	65	54	54	29	67	40	215	HO DLE 305	£52.32	HO DLF 305	£60.91
20	15	16	16	71	103	65	54	54	29	67	40	205	HO DLE 306	£53.93	HO DLF 306	£61.49
25	20	16	19	77	115	70	65	65	34.5	85	49	330	HO DLE 307	£62.61	HO DLF 307	£71.92
32	25	16	22	84	128	78	73	69.5	39	85	49	438	HO DLE 308	£72.21	HO DLF 308	£72.21
40	32	16	26	94	146	88	86	82.5	46	108	64	693	HO DLE 309	£90.04	HO DLF 309	£103.13
50	40	16	31	102	164	93	98	89	52	108	64	925	HO DLE 310	£110.85	HO DLF 310	£129.47
63	50	16	38	123	199	111	122	108	62	134	76	1577	HO DLE 311	£137.09	HO DLF 311	£171.87

VKD DOUBLE UNION BALL VALVES (3/8"/d16 to 2"/d63)

with BSP parallel threaded female ends - Standard valve

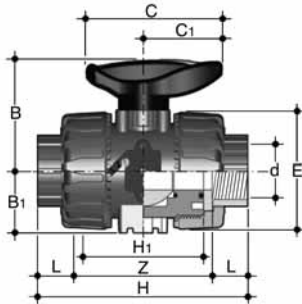

d	DN	PN	L	Z	H	H ₁	E	B	B ₁	C	C ₁	g	Product Code	List Price (£)	Product Code	List Price (£)
													EPDM		FPM	
1/2	15	16	16.5	70	103	65	54	54	29	67	40	210	HO DKE B02	£42.35	HO DKF B02	£51.53
3/4	20	16	19	77	115	70	65	65	34.5	85	49	335	HO DKE B03	£50.29	HO DKF B03	£60.72
1	25	16	22.5	83	128	78	73	69.5	39	85	49	448	HO DKE B04	£61.65	HO DKF B04	£77.37
1 1/4	32	16	26	94	146	88	86	82.5	46	108	64	678	HO DKE B05	£79.40	HO DKF B05	£94.19
1 1/2	40	16	30	104	164	93	98	89	52	108	64	955	HO DKE B06	£104.77	HO DKF B06	£124.07
2	50	16	36	127	199	111	122	108	62	134	76	1667	HO DKE B07	£133.43	HO DKF B07	£167.21

with BSP parallel threaded female ends - Valve, with lockable handle

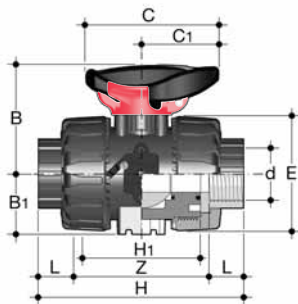

d	DN	PN	L	Z	H	H ₁	E	B	B ₁	C	C ₁	g	Product Code	List Price (£)	Product Code	List Price (£)
													EPDM		FPM	
1/2	15	16	16.5	70	103	65	54	54	29	67	40	210	HO DLE B02	£56.83	HO DLF B02	£66.02
3/4	20	16	19	77	115	70	65	65	34.5	85	49	335	HO DLE B03	£66.48	HO DLF B03	£76.91
1	25	16	22.5	83	128	78	73	69.5	39	85	49	448	HO DLE B04	£77.84	HO DLF B04	£93.56
1 1/4	32	16	26	94	146	88	86	82.5	46	108	64	678	HO DLE B05	£98.14	HO DLF B05	£112.93
1 1/2	40	16	30	104	164	93	98	89	52	108	64	955	HO DLE B06	£123.51	HO DLF B06	£142.81
2	50	16	36	127	199	111	122	108	62	134	76	1667	HO DLE B07	£153.54	HO DLF B07	£187.32

with Flanged ends BS4504 PN10 - Standard valve

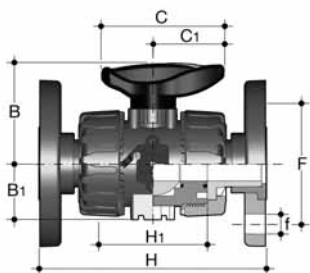

d	DN	PN	H	H ₁	B	B ₁	C	C ₁	F	f	U	g	Product Code	List Price (£)	Product Code	List Price (£)
													EPDM		FPM	
1/2	15	16	-	65	54	29	67	40	60.3	15.9	4	460	HO DKE F02	£61.03	HO DKF F02	£71.72
3/4	20	16	-	70	65	34.5	85	49	69.9	15.9	4	632	HO DKE F03	£71.37	HO DKF F03	£83.96
1	25	16	-	78	69.5	39	85	49	79.4	15.9	4	853	HO DKE F04	£85.80	HO DKF F04	£103.90
1 1/4	32	16	-	88	82.5	46	108	64	88.9	15.9	4	1313	HO DKE F05	£112.65	HO DKF F05	£129.12
1 1/2	40	16	-	93	89	52	108	64	98.4	15.9	4	1669	HO DKE F06	£146.62	HO DKF F06	£166.70
2	50	16	-	111	108	62	134	76	120.7	19.1	4	2577	HO DKE F07	£191.56	HO DKF F07	£224.25

with Flanged ends BS4504 PN10 - Valve, with lockable handle

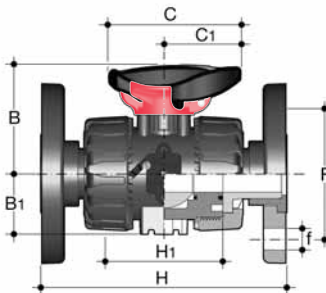

d	DN	PN	H	H ₁	B	B ₁	C	C ₁	F	f	U	g	Product Code	List Price (£)	Product Code	List Price (£)
													EPDM		FPM	
1/2	15	16	-	65	54	29	67	40	60.3	15.9	4	460	HO DLE F02	£75.51	HO DLF F02	£86.21
3/4	20	16	-	70	65	34.5	85	49	69.9	15.9	4	632	HO DLE F03	£87.56	HO DLF F03	£100.15
1	25	16	-	78	69.5	39	85	49	79.4	15.9	4	853	HO DLE F04	£101.98	HO DLF F04	£120.09
1 1/4	32	16	-	88	82.5	46	108	64	88.9	15.9	4	1313	HO DLE F05	£131.39	HO DLF F05	£147.86
1 1/2	40	16	-	93	89	52	108	64	98.4	15.9	4	1669	HO DLE F06	£165.36	HO DLF F06	£185.44
2	50	16	-	111	108	62	134	76	120.7	19.1	4	2577	HO DLE F07	£211.67	HO DLF F07	£244.36

VKD DOUBLE UNION BALL VALVES ($\frac{3}{8}$ "/d16 to 2"/d63)

with Flanged ends ANSI 150 - Standard valve

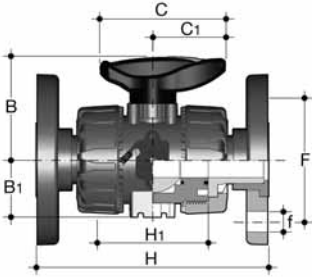

d	DN	PN	H	B	C	F	U	g	Product Code	List Price (£)	Product Code	List Price (£)
									EPDM		FPM	
1/2	15	16	130	49	66	65	4	365	HO DKE X02	£61.03	HO DKF X02	£71.72
3/4	20	16	150	59	75	75	4	520	HO DKE X03	£71.37	HO DKF X03	£83.96
1	25	16	160	66	85	85	4	715	HO DKE X04	£85.80	HO DKF X04	£103.90
1 1/4	32	16	180	75	97	100	4	1060	HO DKE X05	£112.65	HO DKF X05	£129.12
1 1/2	40	16	200	87	110	110	4	1440	HO DKE X06	£146.62	HO DKF X06	£166.70
2	50	16	230	101	134	125	4	2260	HO DKE X07	£191.56	HO DKF X07	£224.25

with Flanged ends ANSI 150 - Valve, with lockable handle

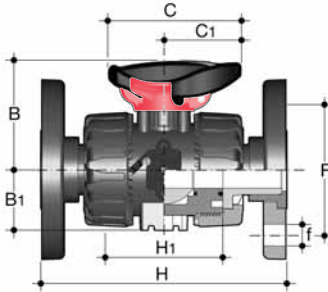

d	DN	PN	H	H1	B	B1	C	C1	F	f	U	g	Product Code	List Price (£)	Product Code	List Price (£)
									EPDM		FPM					
1/2	15	16	-	65	54	29	67	40	60.3	15.9	4	460	HO DLE X02	£75.51	HO DLF X02	£86.21
3/4	20	16	-	70	65	34.5	85	49	69.9	15.9	4	632	HO DLE X03	£87.56	HO DLF X03	£100.15
1	25	16	-	78	69.5	39	85	49	79.4	15.9	4	853	HO DLE X04	£101.98	HO DLF X04	£120.09
1 1/4	32	16	-	88	82.5	46	108	64	88.9	15.9	4	1313	HO DLE X05	£131.39	HO DLF X05	£147.86
1 1/2	40	16	-	93	89	52	108	64	98.4	15.9	4	1669	HO DLE X06	£165.36	HO DLF X06	£185.44
2	50	16	-	111	108	62	134	76	120.7	19.1	4	2577	HO DLE X07	£211.67	HO DLF X07	£244.36

VKD 2-WAY BALL VALVES (2 1/2"/d75 to 4"/d110)

with BS series plain female ends

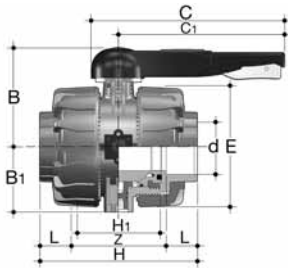

d	DN	PN	Z	L	H	H ₁	E	B	B ₁	C	C ₁	g	Product Code	List Price (£)	Product Code	List Price (£)
													EPDM		FPM	
2 1/2	65	16	147	44	235	133	164	164	87	225	175	4380	HO DKE 312	£251.94	HO DKF 312	£302.34
3	80	16	168	51	270	149	203	177	105	327	272	7200	HO DKE 109	£302.34	HO DKF 109	£371.62
4	100	16	182	63	308	167	238	195	129	385	330	11141	HO DKE 110	£415.70	HO DKF 110	£472.39

with Metric series plain female ends

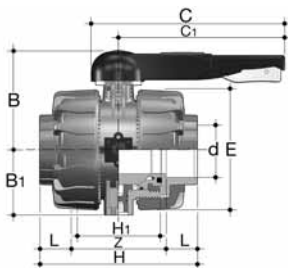

d	DN	PN	Z	L	H	H ₁	E	B	B ₁	C	C ₁	g	Product Code	List Price (£)	Product Code	List Price (£)
													EPDM		FPM	
75	65	16	147	44	235	133	164	164	87	225	175	4380	HO DKE 312	£251.94	HO DKF 312	£302.33
90	80	16	168	51	270	149	203	177	105	327	272	7200	HO DKE 313	£302.33	HO DKF 313	£371.62
110	100	16	186	61	308	167	238	195	129	385	330	11141	HO DKE 314	£415.70	HO DKF 314	£472.39

with BS parallel threaded female ends

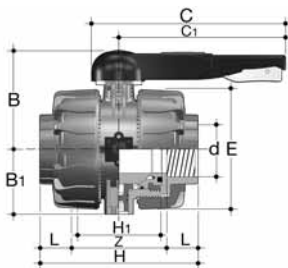

d	DN	PN	Z	L	H	H ₁	E	B	B ₁	C	C ₁	g	Product Code	List Price (£)	Product Code	List Price (£)
													EPDM		FPM	
2 1/2	65	16	174.6	30.2	235	133	164	164	87	225	175	4395	HO DKE B08	£282.79	HO DKF B08	£333.18
3	80	16	203.4	33.3	270	149	203	177	105	327	272	7260	HO DKE B09	£344.36	HO DKF B09	£413.64
4	100	16	229.4	39.3	308	167	238	195	129	385	330	11100	HO DKE B10	£502.89	HO DKF B10	£553.10

with BS 4504 PN10/ANSI 150 backing rings

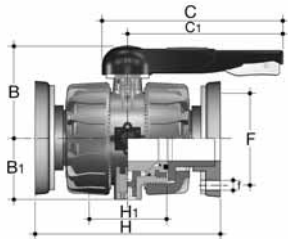

d	DN	PN	H	H ₁	B	B ₁	C	C ₁	f	F	g	Product Code	List Price (£)	Product Code	List Price (£)	
													EPDM		FPM	
75	65	16	290	133	164	87	225	175	17	145	6610	HO DKE F08	£447.20	HO DKF F08	£497.59	
90	80	16	310	149	177	105	327	272	17	160	9330	HO DKE F09	£466.09	HO DKF F09	£535.38	
110	100	16	350	167	195	129	385	330	17	180	13815	HO DKE F10	£636.15	HO DKF F10	£692.84	

VX DOUBLE UNION BALL VALVES

with BS series plain female ends for solvent welding

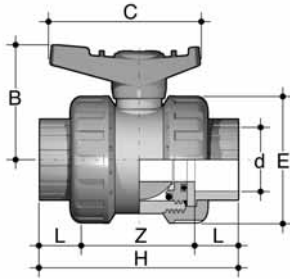

d	DN	PN	L	Z	H	E	B	C	g	Product Code	List Price (£)	Product Code	List Price (£)
										EPDM		FPM	
1/2	15	16	16.5	49	82	53	50.0	65	145	H0 VXE 102	£35.98	H0 VXF 102	£42.81
3/4	20	16	19.0	53	91	62	58.0	76	220	H0 VXE 103	£42.20	H0 VXF 103	£50.46
1	25	16	22.5	58	103	71	65.0	85	315	H0 VXE 104	£50.90	H0 VXF 104	£51.13
1 1/4	32	16	26.0	68	120	84	76.0	100	505	H0 VXE 105	£64.61	H0 VXF 105	£76.80
1 1/2	40	16	30.0	79	139	98	85.5	112	725	H0 VXE 106	£83.92	H0 VXF 106	£100.78
2	50	16	36.0	102	174	117	103.0	137	1245	H0 VXE 107	£106.33	H0 VXF 107	£138.09
2 1/2	65	10	44.0	128	216	154	133.0	222	2600	H0 VXE 312	£228.85	H0 VXF 312	£273.22
3	80	10	50.5	143	244	189	154.0	270	4330	H0 VXE 109	£261.55	H0 VXF 109	£324.83

with Metric series plain female ends for solvent welding

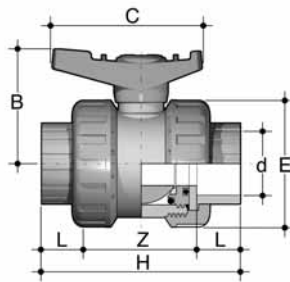

d	DN	PN	L	Z	H	E	B	C	g	Product Code	List Price (£)	Product Code	List Price (£)
										EPDM		FPM	
20	15	16	16	50	82	53	50.0	65	145	H0 VXE 306	£35.98	H0 VXF 306	£42.81
25	20	16	19	53	91	62	58.0	76	220	H0 VXE 307	£42.20	H0 VXF 307	£50.44
32	25	16	22	59	103	71	65.0	85	315	H0 VXE 308	£50.90	H0 VXF 308	£51.07
40	32	16	26	68	120	84	76.0	100	505	H0 VXE 309	£64.61	H0 VXF 309	£76.74
50	40	16	31	77	139	98	85.5	112	725	H0 VXE 310	£83.92	H0 VXF 310	£100.73
63	50	16	38	98	174	117	103.0	137	1245	H0 VXE 311	£106.33	H0 VXF 311	£138.09
75	65	10	44	128	216	154	133.0	222	2600	H0 VXE 312	£228.85	H0 VXF 312	£273.22
90	80	10	51	142	244	189	154.0	270	4330	H0 VXE 313	£261.55	H0 VXF 313	£324.58

with BS parallel threaded female ends

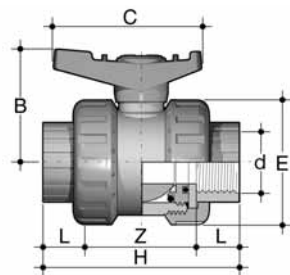

d	DN	PN	L	Z	H	E	B	C	g	Product Code	List Price (£)	Product Code	List Price (£)
										EPDM		FPM	
1/2	15	16	15.0	61.0	91	53	50.0	65	145	H0 VXE B02	£38.50	H0 VXF B02	£46.81
3/4	20	16	16.3	62.4	95	62	58.0	76	220	H0 VXE B03	£45.80	H0 VXF B03	£55.14
1	25	16	19.1	65.8	104	71	65.0	85	315	H0 VXE B04	£55.97	H0 VXF B04	£70.29
1 1/4	32	16	21.4	85.2	128	84	76.0	100	505	H0 VXE B05	£72.29	H0 VXF B05	£85.45
1 1/2	40	16	21.4	88.2	131	98	85.5	112	725	H0 VXE B06	£95.13	H0 VXF B06	£112.77
2	50	16	25.7	111.6	163	117	103.0	137	1245	H0 VXE B07	£121.42	H0 VXF B07	£151.91
2 1/2	65	10	30.2	155.6	216	154	133.0	222	2600	H0 VXE B08	£236.03	H0 VXF B08	£283.25
3	80	10	33.3	177.4	244	189	154.0	270	4330	H0 VXE B09	£300.68	H0 VXF B09	£360.81

VE DOUBLE UNION BALL VALVES

with BS series plain female ends for solvent welding

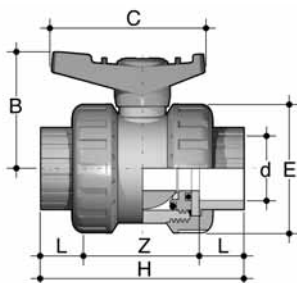

d	DN	PN	L	Z	H	E	B	C	g	Product Code	List Price (£)
EPDM											
1/2	15	16	16.5	49	82	53	50.0	65	145	HO VEE 102	£13.49
3/4	20	16	19.0	53	91	62	58.0	76	220	HO VEE 103	£14.74
1	25	16	22.5	58	103	71	65.0	85	315	HO VEE 104	£19.66
1 1/4	32	16	26.0	68	120	84	76.0	100	505	HO VEE 105	£23.82
1 1/2	40	16	30.0	79	139	98	85.5	112	725	HO VEE 106	£30.65
2	50	16	36.0	102	174	117	103.0	137	1245	HO VEE 107	£42.98
2 1/2	65	10	44.0	128	216	154	133.0	222	2600	HO VEE 312	£101.44
3	80	10	50.5	143	244	189	154.0	270	4330	HO VEE 109	£182.39

with Metric series plain female ends for solvent welding

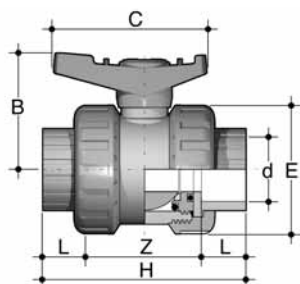

d	DN	PN	L	Z	H	E	B	C	g	Product Code	List Price (£)
EPDM											
20	15	16	16	50	82	53	50.0	65	145	HO VEE 306	£13.49
25	20	16	19	53	91	62	58.0	76	220	HO VEE 307	£14.74
32	25	16	22	59	103	71	65.0	85	315	HO VEE 308	£19.66
40	32	16	26	68	120	84	76.0	100	505	HO VEE 309	£23.83
50	40	16	31	77	139	98	85.5	112	725	HO VEE 310	£30.65
63	50	16	38	98	174	117	103.0	137	1245	HO VEE 311	£42.98
75	65	10	44	128	216	154	133.0	222	2600	HO VEE 312	£101.45
90	80	10	51	142	244	189	154.0	270	4330	HO VEE 313	£182.40

with BS parallel threaded female ends

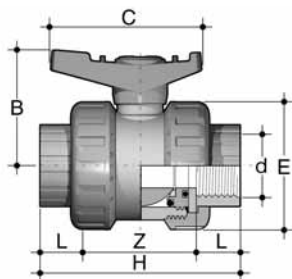

d	DN	PN	L	Z	H	E	B	C	g	Product Code	List Price (£)
EPDM											
1/2	15	16	15.0	61.0	91	53	50.0	65	145	HO VEE B02	£15.06
3/4	20	16	16.3	62.4	95	62	58.0	76	220	HO VEE B03	£16.46
1	25	16	19.1	65.8	104	71	65.0	85	315	HO VEE B04	£21.94
1 1/4	32	16	21.4	85.2	128	84	76.0	100	505	HO VEE B05	£26.60
1 1/2	40	16	21.4	88.2	131	98	85.5	112	725	HO VEE B06	£34.22
2	50	16	25.7	111.6	163	117	103.0	137	1245	HO VEE B07	£47.98
2 1/2	65	10	30.2	155.6	216	154	133.0	222	2600	HO VEE B08	£113.25
3	80	10	33.3	177.4	244	189	154.0	270	4330	HO VEE B09	£203.63

TKD 3-WAY BALL VALVES



with BS series plain female ends for solvent welding (T Port)

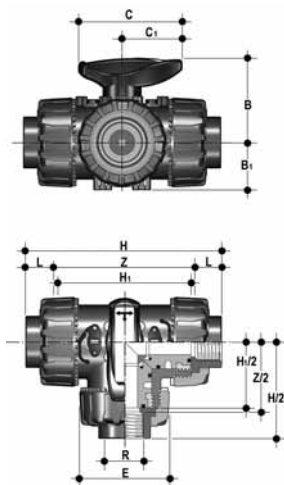

d	DN	PN	H	Z	C	C1	B	B1	g	Product Code	List Price (£)	Product Code	List Price (£)
										EPDM		FPM	
1/2	15	16	125	95	67	40	54	29	310	H0 TTE 102	£68.98	H0 TTF 102	£93.28
3/4	20	16	146	114	85	49	65	34.5	550	H0 TTE 103	£79.79	H0 TTF 103	£108.27
1	25	16	166	129	85	49	65.9	39	790	H0 TTE 104	£98.28	H0 TTF 104	£134.92
1 1/4	32	16	195.5	151	108	64	82.5	46	1275	H0 TTE 105	£110.44	H0 TTF 105	£154.92
1 1/2	40	16	211	166	108	64	89	52	1660	H0 TTE 106	£134.92	H0 TTF 106	£213.55
2	50	16	253.5	199	134	76	108	62	2800	H0 TTE 107	£175.24	H0 TTF 107	£274.03

with Metric series plain female ends for solvent welding (T Port)

d	DN	PN	H	Z	C	C1	B	B1	g	Product Code	List Price (£)	Product Code	List Price (£)
										EPDM		FPM	
20	15	16	118	86	67	40	54	29	310	H0 TTE 306	£68.98	H0 TTF 306	£93.28
25	20	16	145	107	85	49	65	34.5	550	H0 TTE 307	£79.79	H0 TTF 307	£108.27
32	25	16	160	116	85	49	65.9	39	790	H0 TTE 308	£98.28	H0 TTF 308	£134.92
40	32	16	188.5	136.5	108	64	82.5	46	1275	H0 TTE 309	£110.44	H0 TTF 309	£154.92
50	40	16	219	157	108	64	89	52	1660	H0 TTE 310	£134.92	H0 TTF 310	£213.55
63	50	16	266.5	190.5	134	76	108	62	2800	H0 TTE 311	£175.24	H0 TTF 311	£274.03

with BS parallel threaded female ends (T Port)

d	DN	PN	H	Z	C	C1	B	B1	g	Product Code	List Price (£)	Product Code	List Price (£)
										EPDM		FPM	
1/2	15	16	125	95	67	40	54	29	310	H0 TTE B02	£75.45	H0 TTF B02	£102.78
3/4	20	16	146	114	85	49	65	34.5	550	H0 TTE B03	£87.97	H0 TTF B03	£119.26
1	25	16	166	129	85	49	65.9	39	790	H0 TTE B04	£108.45	H0 TTF B04	£150.10
1 1/4	32	16	195.5	151	108	64	82.5	46	1275	H0 TTE B05	£121.61	H0 TTF B05	£167.40
1 1/2	40	16	211	166	108	64	89	52	1660	H0 TTE B06	£152.58	H0 TTF B06	£236.03
2	50	16	253.5	199	134	76	108	62	2800	H0 TTE B07	£193.05	H0 TTF B07	£304.84

See page 79 for a full list of TKD accessories.

TKD 3-WAY BALL VALVES

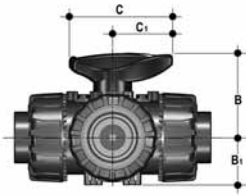

with BS series plain female ends for solvent welding (L Port)

d	DN	PN	H	Z	C	C1	B	B1	g	Product Code	List Price (£)	Product Code	List Price (£)
										EPDM		FPM	
1/2	15	16	125	95	67	40	54	29	310	HO LTE 102	£68.98	HO LTF 102	£93.28
3/4	20	16	146	114	85	49	65	34.5	550	HO LTE 103	£79.79	HO LTF 103	£108.27
1	25	16	166	129	85	49	65.9	39	790	HO LTE 104	£98.28	HO LTF 104	£134.92
1 1/4	32	16	195.5	151	108	64	82.5	46	1275	HO LTE 105	£110.44	HO LTF 105	£154.92
1 1/2	40	16	211	166	108	64	89	52	1660	HO LTE 106	£134.92	HO LTF 106	£213.55
2	50	16	253.5	199	134	76	108	62	2800	HO LTE 107	£175.24	HO LTF 107	£274.03

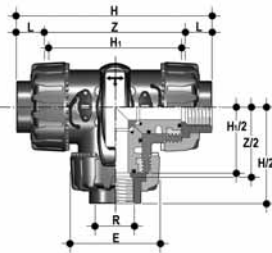

with Metric series plain female ends for solvent welding (L Port)

d	DN	PN	H	Z	C	C1	B	B1	g	Product Code	List Price (£)	Product Code	List Price (£)
										EPDM		FPM	
20	15	16	118	86	67	40	54	29	310	HO LTE 306	£68.98	HO LTF 306	£93.28
25	20	16	145	107	85	49	65	34.5	550	HO LTE 307	£79.79	HO LTF 307	£108.27
32	25	16	160	116	85	49	65.9	39	790	HO LTE 308	£98.28	HO LTF 308	£134.92
40	32	16	188.5	136.5	108	64	82.5	46	1275	HO LTE 309	£110.44	HO LTF 309	£154.92
50	40	16	219	157	108	64	89	52	1660	HO LTE 310	£134.92	HO LTF 310	£213.55
63	50	16	266.5	190.5	134	76	108	62	2800	HO LTE 311	£175.24	HO LTF 311	£274.03

with BS parallel threaded female ends (L Port)

d	DN	PN	H	Z	C	C1	B	B1	g	Product Code	List Price (£)	Product Code	List Price (£)
										EPDM		FPM	
1/2	15	16	125	95	67	40	54	29	310	HO LTE B02	£75.45	HO LTF B02	£102.78
3/4	20	16	146	114	85	49	65	34.5	550	HO LTE B03	£87.97	HO LTF B03	£119.26
1	25	16	166	129	85	49	65.9	39	790	HO LTE B04	£108.45	HO LTF B04	£150.10
1 1/4	32	16	195.5	151	108	64	82.5	46	1275	HO LTE B05	£121.61	HO LTF B05	£167.40
1 1/2	40	16	211	166	108	64	89	52	1660	HO LTE B06	£152.58	HO LTF B06	£236.03
2	50	16	253.5	199	134	76	108	62	2800	HO LTE B07	£193.05	HO LTF B07	£304.84

See page 79 for a full list of TKD accessories.

ACCESSORIES

BALL VALVE ACCESSORIES

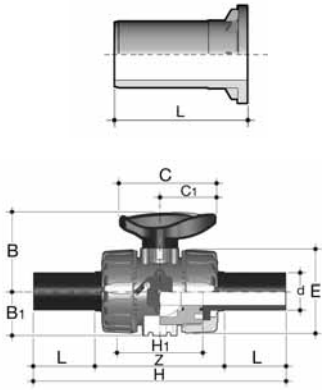

End connectors in PE- VKD, VX, VE, VT, SK, long spigot, for electrofusion or butt weld

d	DN	L	H	Product Code	List Price (£)
20	15	55	175	HZ PEE M06	£5.25
25	20	70	210	HZ PEE M07	£5.37
32	25	74	224	HZ PEE M08	£5.49
40	32	78	243	HZ PEE M09	£8.53
50	40	84	261	HZ PEE M10	£10.14
63	50	91	293	HZ PEE M11	£14.37
75	65	111	356	HZ PEE M12	POA
90	80	118	390	HZ PEE M13	POA
110	100	132	432	HZ PEE M14	POA

End connectors in PP- VKD, VX, VE, VT, SK, long spigot, for electrofusion or butt weld

d	DN	L	H	Product Code	List Price (£)
20	15	55	175	HZ PPE M06	£4.48
25	20	70	210	HZ PPE M07	£5.27
32	25	74	224	HZ PPE M08	£6.46
40	32	78	243	HZ PPE M09	£8.05
50	40	84	261	HZ PPE M10	£10.44
63	50	91	293	HZ PPE M11	£13.45
75	65	111	356	HZ PPE M12	£27.17
90	80	118	390	HZ PPE M13	£34.18
110	100	132	432	HZ PPE M14	£41.41

FK BUTTERFLY VALVES - GRPP BODY WITH PVC-U DISC

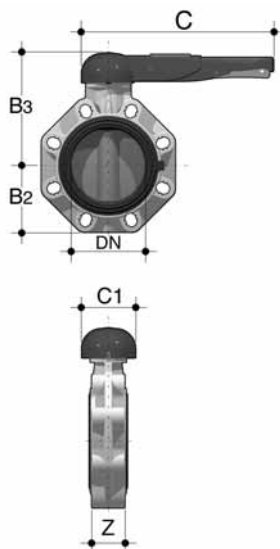

Lever operated - PN10/ANSI/BS10

d	DN	PN	B ₂	B ₃	C	C ₁	Z	g	U	Product Code	List Price (£)	Product Code	List Price (£)
										EPDM		FPM	
1½	40	16	60	137	175	100	33	900	4	HO FKE 106	£123.64	HO FKF 106	£149.51
2	50	16	70	143	175	100	43	1080	4	HO FKE 107	£130.42	HO FKF 107	£158.42
2½	65	10	80	164	272	110	46	1470	4	HO FKE 108	£143.23	HO FKF 108	£175.88
3	80	10	93	178	272	110	49	1870	8	HO FKE 109	£157.85	HO FKF 109	£184.49
4	100	10	107	192	272	110	56	2220	8	HO FKE 110	£191.18	HO FKF 110	£220.30
5	125	10	120	212	330	110	64	3100	8	HO FKE 111	£247.53	HO FKF 111	£277.11
6	150	10	134	225	330	110	70	3850	8	HO FKE 112	£304.36	HO FKF 112	£340.17
8	200	10	161	272	420	122	71	6750	8	HO FKE 113	£453.03	HO FKF 113	£496.62

Lever operated - LUGGED BS 4504, PN10

d	DN	PN	B ₂	B ₃	C	C ₁	Z	g	U	Product Code	List Price (£)	Product Code	List Price (£)
										EPDM		FPM	
2½	65	10	80	164	272	110	46	1470	4	HO FKE F08	£223.02	HO FKF F08	£301.90
3	80	10	93	178	272	110	49	1870	8	HO FKE F09	£258.92	HO FKF F09	£347.87
4	100	10	107	192	272	110	56	2220	8	HO FKE F10	£318.70	HO FKF F10	£439.32
5	125	10	120	212	330	110	64	3100	8	HO FKE F11	£404.99	HO FKF F11	£559.82
6	150	10	134	225	330	110	70	3850	8	HO FKE F12	£492.12	HO FKF F12	£680.15
8	200	10	161	272	420	122	71	6750	8	HO FKE F13	£611.28	HO FKF F13	£883.23

Lever operated - LUGGED ANSI 150

d	DN	PN	B ₂	B ₃	C	C ₁	Z	g	U	Product Code	List Price (£)	Product Code	List Price (£)
										EPDM		FPM	
2½	65	10	80	164	272	110	46	1470	4	HO FKE X08	£254.93	HO FKF X08	£333.81
3	80	10	93	178	272	110	49	1870	8	HO FKE X09	£293.42	HO FKF X09	£382.46
4	100	10	107	192	272	110	56	2220	8	HO FKE X10	£361.39	HO FKF X10	£482.00
5	125	10	120	212	330	110	64	3100	8	HO FKE X11	£458.98	HO FKF X11	£613.80
6	150	10	134	225	330	110	70	3850	8	HO FKE X12	£558.02	HO FKF X12	£746.04
8	200	10	161	272	420	122	71	6750	8	HO FKE X13	£698.24	HO FKF X13	£970.19

FK BUTTERFLY VALVES - GRPP BODY WITH PVC-U DISC

Gear box operated - PN10/ANSI/BS10

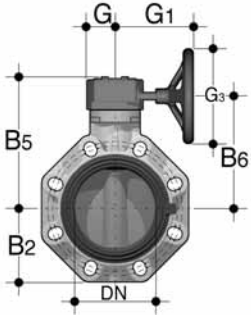

d	DN	PN	B2	B5	B6	G	G1	G2	G3	Z	g	U	Product Code	List Price (£)	Product Code	List Price (£)
													EPDM		FPM	
2½	65	10	80	174	146	48	135	39	125	46	2400	4	HV FKE 108	£354.60	HV FKF 108	£387.25
3	80	10	93	188	160	48	135	39	125	49	2800	8	HV FKE 109	£369.23	HV FKF 109	£395.86
4	100	10	107	202	174	48	135	39	125	56	3150	8	HV FKE 110	£402.55	HV FKF 110	£431.67
5	125	10	120	222	194	48	144	39	200	64	4450	8	HV FKE 111	£458.90	HV FKF 111	£488.48
6	150	10	134	235	207	48	144	39	200	70	5200	8	HV FKE 112	£515.74	HV FKF 112	£551.54
8	200	10	161	287	256	65	204	60	200	71	9300	8	HV FKE 113	£711.62	HV FKF 113	£755.20
10	250	10	210	317	281	88	236	76	250	114	18600	12	HV FKE 114	£1,233.64	HV FKF 114	£2,106.53
12	300	8	245	374	338	88	236	76	250	114	25600	12	HV FKE 115	£1,330.75	HV FKF 115	£2,280.72



Gear box operated - LUGGED BS 4504, PN10

d	DN	PN	B2	B5	B6	G	G1	G2	G3	Z	g	U	Product Code	List Price (£)	Product Code	List Price (£)
													EPDM		FPM	
2½	65	10	80	174	146	48	135	39	125	46	2400	4	HV FKE F08	£434.40	HV FKF F08	£301.90
3	80	10	93	188	160	48	135	39	125	49	2800	8	HV FKE F09	£470.29	HV FKF F09	£347.97
4	100	10	107	202	174	48	135	39	125	56	3150	8	HV FKE F10	£530.07	HV FKF F10	£439.32
5	125	10	120	222	194	48	144	39	200	64	4450	8	HV FKE F11	£616.37	HV FKF F11	£559.82
6	150	10	134	235	207	48	144	39	200	70	5200	8	HV FKE F12	£703.49	HV FKF F12	£680.15
8	200	10	161	287	256	65	204	60	200	71	9300	8	HV FKE F13	£869.86	HV FKF F13	£883.23

Suitable for end of line applications

Gear box operated - LUGGED ANSI 150

d	DN	PN	B2	B5	B6	G	G1	G2	G3	Z	g	U	Product Code	List Price (£)	Product Code	List Price (£)
													EPDM		FPM	
2½	65	10	80	174	146	48	135	39	125	46	2400	4	HV FKE X08	£466.30	HV FKF X08	£545.18
3	80	10	93	188	160	48	135	39	125	49	2800	8	HV FKE X09	£504.79	HV FKF X09	£593.83
4	100	10	107	202	174	48	135	39	125	56	3150	8	HV FKE X10	£572.76	HV FKF X10	£693.38
5	125	10	120	222	194	48	144	39	200	64	4450	8	HV FKE X11	£670.35	HV FKF X11	£825.17
6	150	10	134	235	207	48	144	39	200	70	5200	8	HV FKE X12	£769.39	HV FKF X12	£957.41
8	200	10	161	287	256	65	204	60	200	71	9300	8	HV FKE X13	£956.82	HV FKF X13	£1,228.62

Suitable for end of line applications

FE BUTTERFLY VALVES

PVC-U
imperial & metric
MANUAL VALVES

Lever operated - PN10/ANSI

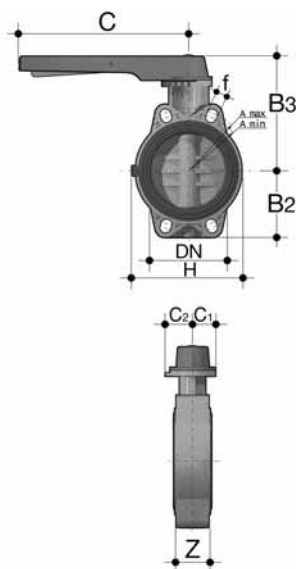

d	DN	PN	B ₂	B ₃	C	C ₁	C ₂	H	Z	A min	A max	f	g	U	Product Code	List Price (£)
EPDM																
1½	40	16	60	136	175	45	42	132	33	93.5	109	19	827	4	HO FEE 106	£77.93
2	50	16	70	143	175	45	42	147	43	108	124	19	1012	4	HO FEE 107	£82.49
2½	65	10	80	168	250	45	53	165	46	128	144	19	1420	4	HO FEE 108	£91.67
3	80	10	90	182	250	45	53	130	49	145	159	19	1640	4	HO FEE 109	£94.13
4	100	10	105	196	250	45	53	150	56	165	190	19	1990	4	HO FEE 110	£113.95
5	125	10	121	215	335	45	53	185	64	204	215	23	3030	4	HO FEE 111	£148.65
6	150	10	132	229	335	45	53	210	70	230	242	23	3730	4	HO FEE 112	£188.28
8	200	10	161	309	425	65	82	325	71	280	298	23	8240	8	HO FEE 113	£305.22

Gear box operated - PN10/ANSI

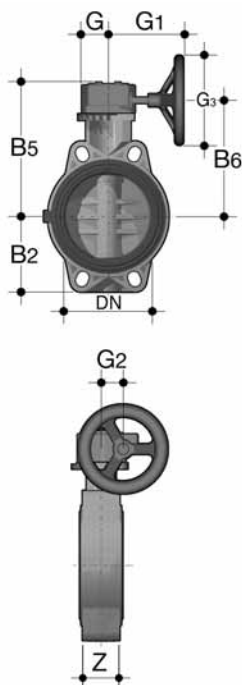

d	DN	PN	B ₂	B ₅	B ₆	G	G ₁	G ₂	G ₃	g	U	Product Code	List Price (£)
EPDM													
2½	65	10	80	173	145	48	135	39	125	2380	4	HV FEE 108	£303.04
3	80	10	90	187	159	48	135	39	125	2600	4	HV FEE 109	£305.51
4	100	10	105	201	173	48	135	39	125	2950	4	HV FEE 110	£325.33
5	125	10	121	220	192	48	144	39	200	4400	4	HV FEE 111	£360.01
6	150	10	132	235	207	48	144	39	200	5100	4	HV FEE 112	£399.64
8	200	10	161	288	257	65	175	60	200	9260	8	HV FEE 113	£563.81

VM DIAPHRAGM VALVES

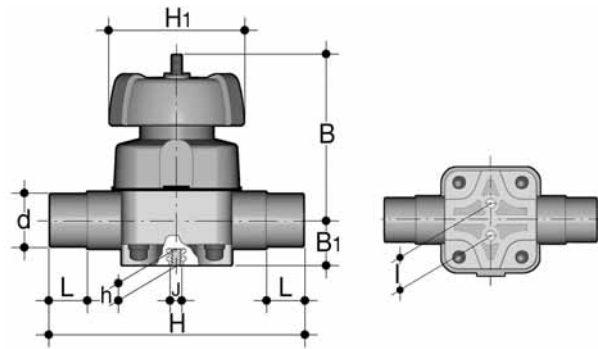

BS series plain male ends

d	DN	PN	B	B ₁	H	h	H ₁	I	J	L	g	Product Code	List Price (£)	Product Code	List Price (£)	Product Code	List Price (£)
												EPDM		FPM		PTFE	
1/2	15	10	95	26	124	12	90	25	M6	16	700	HO VME 202	£53.15	HO VMF 202	£70.29	HO VMG 202	£114.09
3/4	20	10	95	26	144	12	90	25	M6	19	700	HO VME 203	£62.81	HO VMF 203	£82.80	HO VMG 203	£124.45
1	25	10	95	26	154	12	90	25	M6	23	700	HO VME 204	£78.13	HO VMF 204	£98.95	HO VMG 204	£144.92
1 1/4	32	10	126	40	174	18	115	44.5	M8	27	1500	HO VME 205	£94.77	HO VMF 205	£121.29	HO VMG 205	£190.57
1 1/2	40	10	126	40	194	18	115	44.5	M8	32	1500	HO VME 206	£126.27	HO VMF 206	£159.43	HO VMG 206	£238.21
2	50	10	148	40	224	18	140	44.5	M8	39	2400	HO VME 207	£155.25	HO VMF 207	£196.74	HO VMG 207	£296.51
2 1/2	65	10	225	55	284	23	215	100	M12	44	7000	HO VME 412	£291.51	HO VMF 412	£358.15	HO VMG 412	£499.73
3	80	10	225	55	300	23	215	100	M12	51	7000	HO VME 209	£440.60	HO VMF 209	£523.06	HO VMG 209	£684.64
4	100	10	295	69	350	23	250	120	M12	-	10500	HO VME 210	£618.01	HO VMF 210	£734.60	HO VMG 210	£904.52

Metric series plain male ends

d	DN	PN	B	B ₁	H	h	H ₁	I	J	L	g	Product Code	List Price (£)	Product Code	List Price (£)	Product Code	List Price (£)
												EPDM		FPM		PTFE	
20	15	10	95	26	124	12	90	25	M6	16	700	HO VME 406	£53.10	HO VMF 406	£70.37	HO VMG 406	£114.13
25	20	10	95	26	144	12	90	25	M6	19	700	HO VME 407	£62.75	HO VMF 407	£82.83	HO VMG 407	£122.85
32	25	10	95	26	154	12	90	25	M6	23	700	HO VME 408	£78.15	HO VMF 408	£99.01	HO VMG 408	£144.94
40	32	10	126	40	174	18	115	44.5	M8	27	1500	HO VME 409	£94.82	HO VMF 409	£121.29	HO VMG 409	£190.56
50	40	10	126	40	194	18	115	44.5	M8	32	1500	HO VME 410	£138.40	HO VMF 410	£159.43	HO VMG 410	£238.20
63	50	10	148	40	224	18	140	44.5	M8	39	2400	HO VME 411	£155.22	HO VMF 411	£196.78	HO VMG 411	£296.57
75	65	10	225	55	284	23	215	100	M12	44	7000	HO VME 412	£291.51	HO VMF 412	£358.07	HO VMG 412	£499.73
90	80	10	225	55	300	23	215	100	M12	51	7000	HO VME 413	£440.58	HO VMF 413	£523.10	HO VMG 413	£684.99
110	100	10	295	69	350	23	250	120	M12	-	10500	HO VME 414	£618.05	HO VMF 414	£734.82	HO VMG 414	£904.51

VM DIAPHRAGM VALVES

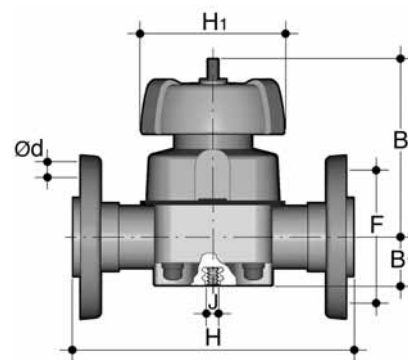

PVC-U
 imperial & metric
MANUAL VALVES

with Flanges to BS 4504 PN10

d	DN	PN	B	B ₁	H	U	H ₁	F	J	Ød	g	Product Code	List Price (£)	Product Code	List Price (£)	Product Code	List Price (£)
												EPDM		FPM		PTFE	
1/2	15	10	95	26	130	4	90	65	M6	14	840	HO VME F02	£69.91	HO VMF F02	£87.18	HO VMG F02	£130.94
3/4	20	10	95	26	150	4	90	75	M6	14	902	HO VME F03	£81.13	HO VMF F03	£101.21	HO VMG F03	£141.23
1	25	10	95	26	160	4	90	85	M6	14	990	HO VME F04	£98.08	HO VMF F04	£118.94	HO VMG F04	£164.87
1 1/4	32	10	126	40	180	4	115	100	M8	18	1960	HO VME F05	£121.82	HO VMF F05	£148.21	HO VMG F05	£217.48
1 1/2	40	10	126	40	200	4	115	110	M8	18	2070	HO VME F06	£169.69	HO VMF F06	£190.70	HO VMG F06	£269.48
2	50	10	148	40	230	4	140	125	M8	18	3170	HO VME F07	£199.77	HO VMF F07	£241.32	HO VMG F07	£342.13
2 1/2	65	10	225	55	290	4	215	145	M12	18	8100	HO VME F08	£348.95	HO VMF F08	£415.51	HO VMG F08	£557.18
3	80	10	225	55	310	8	215	160	M12	18	8470	HO VME F09	£506.91	HO VMF F09	£589.43	HO VMG F09	£751.33
4	100	10	295	69	350	8	250	180	M12	18	12420	HO VME F10	£699.66	HO VMF F10	£816.42	HO VMG F10	£986.12

with Flanges to ANSI 150

d	DN	PN	B	B ₁	H	U	H ₁	F	J	Ød	g	Product Code	List Price (£)	Product Code	List Price (£)	Product Code	List Price (£)
												EPDM		FPM		PTFE	
1/2	15	10	95	26	130	4	90	60.3	M6	15.9	840	HO VME X02	£69.91	HO VMF X02	£87.18	HO VMG X02	£130.94
3/4	20	10	95	26	150	4	90	69.9	M6	15.9	902	HO VME X03	£81.13	HO VMF X03	£101.21	HO VMG X03	£141.23
1	25	10	95	26	160	4	90	79.4	M6	15.9	990	HO VME X04	£98.08	HO VMF X04	£118.94	HO VMG X04	£164.87
1 1/4	32	10	126	40	180	4	115	88.9	M8	15.9	1960	HO VME X05	£121.82	HO VMF X05	£148.21	HO VMG X05	£217.48
1 1/2	40	10	126	40	200	4	115	98.4	M8	15.9	2074	HO VME X06	£169.69	HO VMF X06	£190.70	HO VMG X06	£269.48
2	50	10	148	40	230	4	140	120.7	M8	19.1	3170	HO VME X07	£199.76	HO VMF X07	£241.32	HO VMG X07	£342.13
2 1/2	65	10	225	55	290	4	215	139.7	M12	19.1	8100	HO VME X08	£348.95	HO VMF X08	£415.51	HO VMG X08	£557.18
3	80	10	225	55	310	4	215	152.4	M12	19.1	8470	HO VME X09	£506.91	HO VMF X09	£589.43	HO VMG X09	£751.33
4	100	10	295	69	350	8	250	190.5	M12	19.1	12420	HO VME X10	£699.66	HO VMF X10	£816.42	HO VMG X10	£986.12

VM DIAPHRAGM VALVES

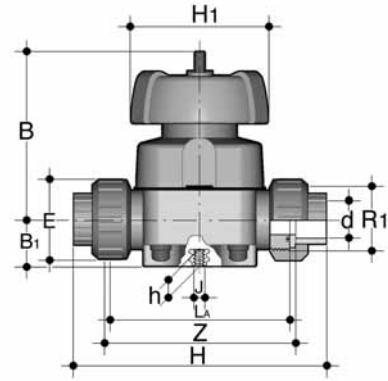

with unionised BS series plain female ends

d	DN	PN	B	B ₁	H	h	H ₁	L _A	J	L _B	R ₁	g	Product Code	List Price (£)	Product Code	List Price (£)	Product Code	List Price (£)
													EPDM		FPM		PTFE	
1/2	15	10	95	20.5	146	12	90	108	M6	114	1	830	HO UME 102	£74.59	HO UMF 102	£124.63	HO UMG 102	£149.09
3/4	20	10	95	20.5	152	12	90	108	M6	114	1 1/4	860	HO UME 103	£81.59	HO UMF 103	£137.45	HO UMG 103	£160.78
1	25	10	95	25	166	12	90	116	M6	122	1 1/2	895	HO UME 104	£101.33	HO UMF 104	£157.24	HO UMG 104	£180.53
1 1/4	32	10	126	36	192	16	115	134	M8	140	2	1650	HO UME 105	£121.27	HO UMF 105	£211.98	HO UMG 105	£237.67
1 1/2	40	10	126	39.5	222	16	115	154	M8	160	2 1/4	1730	HO UME 106	£165.39	HO UMF 106	£262.12	HO UMG 106	£287.73
2	50	10	148	49	266	16	140	184	M8	190	2 3/4	2800	HO UME 107	£203.84	HO UMF 107	£357.62	HO UMG 107	£393.52

with unionised Metric series plain female ends

d	DN	PN	B	B ₁	H	h	H ₁	L _A	J	L _B	R ₁	g	Product Code	List Price (£)	Product Code	List Price (£)	Product Code	List Price (£)
													EPDM		FPM		PTFE	
20	15	10	95	20.5	146	12	90	108	M6	114	1	830	HO UME 306	£74.59	HO UMF 306	£124.63	HO UMG 306	£149.08
25	20	10	95	20.5	152	12	90	108	M6	114	1 1/4	860	HO UME 307	£81.59	HO UMF 307	£137.49	HO UMG 307	£160.78
32	25	10	95	25	166	12	90	116	M6	122	1 1/2	895	HO UME 308	£101.34	HO UMF 308	£157.24	HO UMG 308	£180.53
40	32	10	126	36	192	16	115	134	M8	140	2	1650	HO UME 309	£121.27	HO UMF 309	£211.98	HO UMG 309	£237.67
50	40	10	126	39.5	222	16	115	154	M8	160	2 1/4	1730	HO UME 310	£165.39	HO UMF 310	£262.12	HO UMG 310	£287.73
63	50	10	148	49	266	16	140	184	M8	190	2 3/4	2800	HO UME 311	£203.84	HO UMF 311	£357.62	HO UMG 311	£393.52

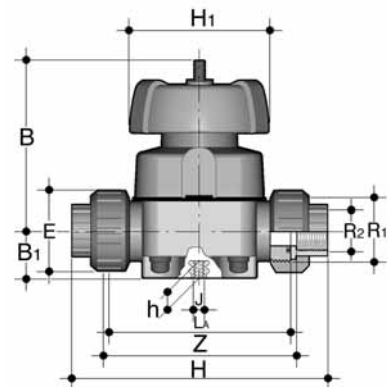

with unionised BS parallel threaded female ends

R ₂	DN	PN	B	B ₁	H	h	H ₁	L _A	J	L _B	R ₁	g	Product Code	List Price (£)	Product Code	List Price (£)	Product Code	List Price (£)
													EPDM		FPM		PTFE	
1/2	15	10	95	20.5	146	12	90	108	M6	114	1	830	HO UME B02	£79.19	HO UMF B02	£129.23	HO UMG B02	£153.68
3/4	20	10	95	20.5	152	12	90	108	M6	114	1 1/4	860	HO UME B03	£86.78	HO UMF B03	£142.68	HO UMG B03	£165.97
1	25	10	95	25	166	12	90	116	M6	122	1 1/2	895	HO UME B04	£108.61	HO UMF B04	£164.50	HO UMG B04	£187.80
1 1/4	32	10	126	36	192	16	115	134	M8	140	2	1650	HO UME B05	£131.05	HO UMF B05	£221.76	HO UMG B05	£247.46
1 1/2	40	10	126	39.5	222	16	115	154	M8	160	2 1/4	1730	HO UME B06	£178.44	HO UMF B06	£275.17	HO UMG B06	£300.78
2	50	10	148	49	266	16	140	184	M8	190	2 3/4	2800	HO UME B07	£219.70	HO UMF B07	£373.49	HO UMG B07	£409.38

CM COMPACT DIAPHRAGM VALVES

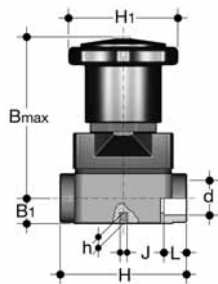

with Metric series plain female ends

d	DN	PN	B	B ₁	H ₁	H	h	I	J	L	g	Product Code	List Price (£)	Product Code	List Price (£)	Product Code	List Price (£)
			max														
16	12	6	86	15	58.5	75	8	35	M5	14	270	HO CME 305	£40.02	HO CMF 305	£55.11	HO CMG 305	£61.97
20	15	6	86	15	58.5	75	8	35	M5	16	270	HO CME 306	£49.82	HO CMF 306	£62.58	HO CMG 306	£67.42

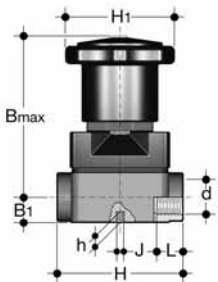

with BSP parallel threaded female ends

d	DN	PN	B	B ₁	H ₁	H	h	I	J	L	g	Product Code	List Price (£)	Product Code	List Price (£)	Product Code	List Price (£)
			max														
3/8	12	6	86	15	58.5	75	8	35	M5	17	270	HO CME B01	£40.16	HO CMF B01	£55.30	HO CMG B01	£62.13
1/2	15	6	86	15	58.5	75	8	35	M5	17	270	HO CME B02	£55.13	HO CMF B02	£70.79	HO CMG B02	£73.97

with unionised BS series plain female ends

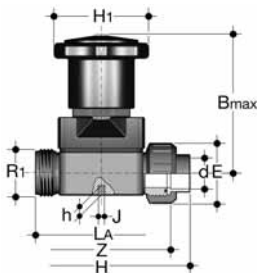

d	DN	PN	B	H ₁	H	h	I	J	LA	Z	R ₁	E	g	Product Code	List Price (£)	Product Code	List Price (£)	Product Code	List Price (£)
1/2	15	6	86	58.5	129.5	8	35	M5	90	97.5	1"	41	285	HO CUE 102	£55.11	HO CUF 102	£70.40	HO CUG 102	£73.96

with unionised Metric series plain female ends

d	DN	PN	B	H ₁	H	h	I	J	LA	Z	R ₁	E	g	Product Code	List Price (£)	Product Code	List Price (£)	Product Code	List Price (£)
20	15	6	86	58.5	129.5	8	35	M5	90	97.5	1"	41	285	HO CUE 306	£55.11	HO CUF 306	£70.84	HO CUG 306	£73.96

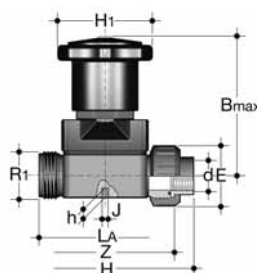

with unionised BSP parallel threaded female ends

d	DN	PN	B	H ₁	H	h	I	J	LA	Z	R ₁	E	g	Product Code	List Price (£)	Product Code	List Price (£)	Product Code	List Price (£)
1/2	15	6	86	58.5	129.5	8	35	M5	90	97.5	1"	41	285	HO CUE B02	£55.14	HO CUF B02	£70.78	HO CUG B02	£73.97

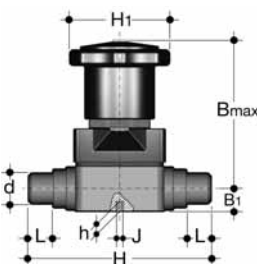

with Metric series plain male ends

d	DN	PN	B	B ₁	H ₁	H	h	I	J	L	g	Product Code	List Price (£)	Product Code	List Price (£)	Product Code	List Price (£)
20	15	6	86	15	58.5	124	8	35	M5	16	310	HO CME 406	£47.81	HO CMF 406	£68.04	HO CMG 406	£71.92

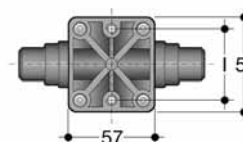
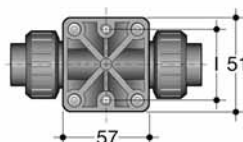
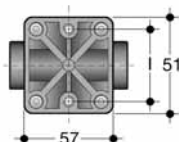

VM MINI DIAPHRAGM VALVES

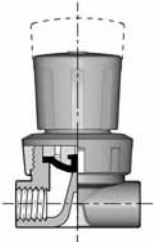

with BS parallel threaded female ends

d	DN	PN	L	H ₁	H ₂	H	E	Z	g	Product Code	List Price (£)
EPDM											
1/4	8	10	10.5	72	81	48	43	27	70	HO VME B00	£31.82

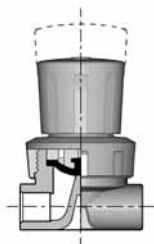

with Metric series plain female ends for solvent welding

d	DN	PN	L	H ₁	H ₂	H	E	Z	g	Product Code	List Price (£)
EPDM											
12	8	10	12	72	81	48	43	24	70	HO CME 304	£31.82

RM MINI DIAPHRAGM COCKS

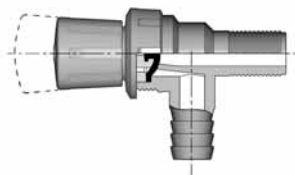

with one BS parallel threaded male end and the other end for hose connection

d	P	DN	PN	H	H ₁	L ₁	L	E	B	g	Product Code	List Price (£)
EPDM												
1/2	20	15	4	110	119	29	24	43	50	90	HO CME 102	£31.15

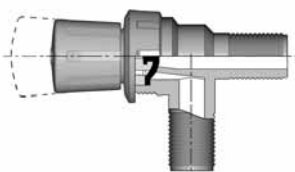

with BS parallel threaded male ends

d	DN	PN	H	H ₁	L ₁	L	E	B	g	Product Code	List Price (£)
EPDM											
1/2	15	4	110	119	28	16	43	50	90	HO RME T02	£31.48

VZ FOOT VALVES

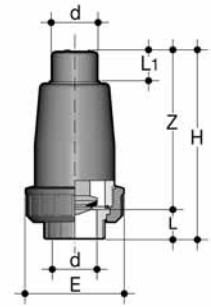

with Metric series ends for solvent welding

d	DN	PN	E	L	L ₁	Z	H	g	Product Code	List Price (£)
EPDM										
16	10	16	55	14	15	87	101	105	HO VZE 305	£48.26
20	15	16	55	16	18	87	103	120	HO VZE 306	£57.60
25	20	16	66	19	20	106	125	210	HO VZE 307	£66.17
32	25	16	75	22	24	128	150	350	HO VZE 308	£93.41
40	32	16	87	26	28	145	171	560	HO VZE 309	£104.31
50	40	16	100	31	34	156	187	760	HO VZE 310	£111.16
63	50	16	122	38	41	185	223	1340	HO VZE 311	£125.17

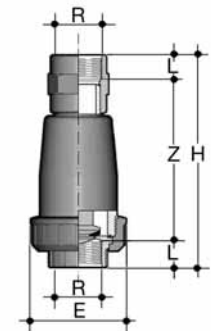

with BS parallel threaded female ends

d	DN	PN	E	L	Z	H	g	Product Code	List Price (£)
EPDM									
1/2	15	16	55	15.0	93	123	135	HO VZE B02	£67.18
3/4	20	16	66	16.3	113.4	146	230	HO VZE B03	£76.80
1	25	16	75	19.1	135.8	174	390	HO VZE B04	£106.17
1 1/4	32	16	87	21.4	157.2	200	620	HO VZE B05	£121.19
1 1/2	40	16	100	21.4	166.2	209	860	HO VZE B06	£130.48
2	50	16	122	25.7	196.6	248	1520	HO VZE B07	£152.98

VA AIR RELEASE VALVES

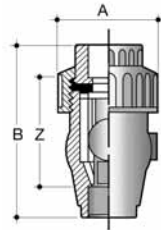

with BS series plain female ends for solvent welding

d	Z	A	B	gms	Product Code	List Price (£)
EPDM						
1/2	62	48	95	100	HO VAE 102	£57.97
3/4	73	59	112	165	HO VAE 103	£66.99
1	79	69	124	250	HO VAE 104	£82.42
1 1/4	94	96	148	610	HO VAE 105	£89.20
1 1/2	88	96	148	575	HO VAE 106	£119.77
2	105	103	177	798	HO VAE 107	£162.10

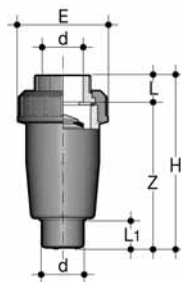

with Metric series ends for solvent welding

d	DN	PN	E	L	L1	Z	H	g	Product Code	List Price (£)
EPDM										
20	15	16	55	16	18	87	103	105	HO VAE 307	£51.69
25	20	16	66	19	20	106	125	185	HO VAE 306	£58.53
32	25	16	75	22	24	128	150	280	HO VAE 308	£96.99
40	32	16	87	26	28	145	171	415	HO VAE 309	£76.60
50	40	16	100	31	34	156	187	570	HO VAE 310	£97.15
63	50	16	122	38	41	185	223	950	HO VAE 311	£134.98

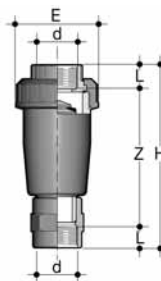

with BS parallel threaded female ends

d	DN	PN	E	L	Z	H	g	Product Code	List Price (£)
EPDM									
1/2	15	16	55	15.0	93	123	120	HO VAE B02	£83.12
3/4	20	16	66	16.3	113.4	146	205	HO VAE B03	£83.12
1	25	16	75	19.1	135.8	174	360	HO VAE B04	£96.95
1 1/4	32	16	87	21.4	157.2	200	475	HO VAE B05	£96.95
1 1/2	40	16	100	21.4	166.2	209	670	HO VAE B06	£137.60
2	50	16	120	25.7	196.6	248	1130	HO VAE B07	£137.60

SR BALL CHECK VALVES

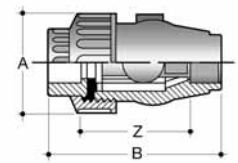

with BS series plain female ends for solvent welding

d	Z	A	B	gms	Product Code	List Price (£)
EPDM						
1/2	62	48	95	100	HO SRE 102	£42.45
3/4	73	59	112	165	HO SRE 103	£48.64
1	79	69	124	250	HO SRE 104	£52.32
1 1/4	94	96	148	610	HO SRE 105	£63.14
1 1/2	88	96	148	575	HO SRE 106	£76.95
2	105	103	177	798	HO SRE 107	£110.43
3	114	178	215	2757	HO SRE 109	£295.68

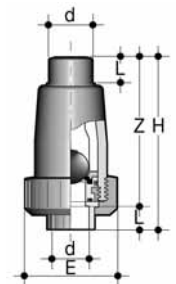

with Metric series ends for solvent welding

d	DN	PN	E	L	Z	H	g	Product Code	List Price (£)
EPDM									
20	15	16	55	16	86	102	110	HO SRE 306	£42.52
25	20	16	66	19	105	124	205	HO SRE 307	£48.57
32	25	16	75	22	127	149	310	HO SRE 308	£52.32
40	32	16	87	26	146	172	475	HO SRE 309	£62.27
50	40	16	100	31	156	187	660	HO SRE 310	£64.61
63	50	16	120	38	186	224	1120	HO SRE 311	£110.39

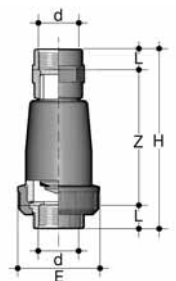

with BSP parallel threaded female ends

d	DN	PN	E	L	Z	H	g	Product Code	List Price (£)
EPDM									
1/2	15	16	55	15.0	93	123	120	HO SRE B02	£52.09
3/4	20	16	66	16.3	113.4	146	205	HO SRE B03	£59.20
1	25	16	75	19.1	135.8	174	360	HO SRE B04	£65.07
1 1/4	32	16	87	21.4	157.2	200	475	HO SRE B05	£79.16
1 1/2	40	16	100	21.4	166.2	209	670	HO SRE B06	£83.93
2	50	16	120	25.7	196.6	248	1130	HO SRE B07	£138.20

VR ANGLE SEAT CHECK VALVES

with unionised BS series plain female ends for solvent welding

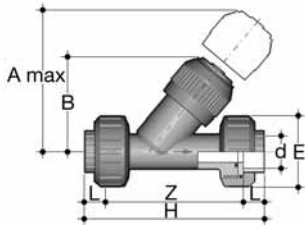

d	DN	PN	A max	B	E	L	Z	H	Fig	g	Product Code	List Price (£)	Product Code	List Price (£)
											EPDM		FPM	
3/8	10	16	125	72	55	14	107	135	A	218	HO URE 101	£40.50	HO URF 101	£78.29
1/2	15	16	125	72	55	16	103	135	A	226	HO URE 102	£50.21	HO URF 102	£91.54
3/4	20	16	145	84	66	19	120	158	A	388	HO URE 103	£57.03	HO URF 103	£97.19
1	25	16	165	95	75	22	132	176	A	606	HO URE 104	£68.34	HO URF 104	£103.45
1 1/4	32	16	190	111	87	26	155	207	A	923	HO URE 105	£91.54	HO URF 105	£138.05
1 1/2	40	16	210	120	100	31	181	243	A	1335	HO URE 106	£131.77	HO URF 106	£197.26
2	50	16	240	139	120	38.2	221.6	298	A	2313	HO URE 107	£219.27	HO URF 107	£293.20

with unionised Metric series plain female ends for solvent welding

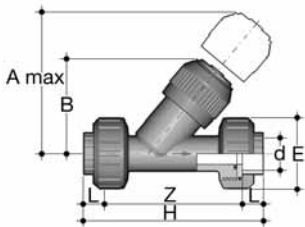

d	DN	PN	A max	B	E	L	Z	H	Fig	g	Product Code	List Price (£)	Product Code	List Price (£)
											EPDM		FPM	
16	10	16	125	72	55	14	107	135	A	218	HO URE 305	£42.40	HO URF 305	£62.35
20	15	16	125	72	55	16	103	135	A	226	HO URE 306	£54.56	HO URF 306	£71.17
25	20	16	145	84	66	19	120	158	A	388	HO URE 307	£58.52	HO URF 307	£84.88
32	25	16	165	95	75	22	132	176	A	606	HO URE 308	£68.34	HO URF 308	£103.45
40	32	16	190	111	87	26	155	207	A	923	HO URE 309	£91.54	HO URF 309	£138.05
50	40	16	210	120	100	31	181	243	A	1335	HO URE 310	£131.77	HO URF 310	£197.26
63	50	16	240	139	120	38.2	221.6	298	A	2313	HO URE 311	£219.27	HO URF 311	£293.20

with unionised BS parallel threaded female ends

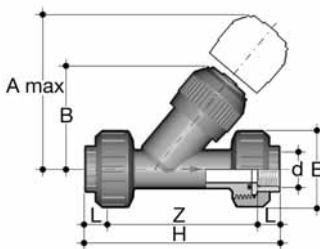

d	DN	PN	A max	B	E	L	Z	H	Fig.	g	Product Code	List Price (£)	Product Code	List Price (£)
											EPDM		FPM	
3/8	10	16	125	72	55	11.4	112.2	135	A	221	HO URE B01	£44.93	HO URF B01	£66.05
1/2	15	16	125	72	55	15.0	112.0	142	A	230	HO URE B02	£57.08	HO URF B02	£74.44
3/4	20	16	145	84	66	16.3	126.4	159	A	390	HO URE B03	£62.12	HO URF B03	£90.09
1	25	16	165	95	75	19.1	144.8	183	A	602	HO URE B04	£73.39	HO URF B04	£111.11
1 1/4	32	16	190	111	87	21.4	171.2	214	A	932	HO URE B05	£99.19	HO URF B05	£149.59
1 1/2	40	16	210	120	100	21.4	192.2	235	A	1341	HO URE B06	£142.93	HO URF B06	£213.96
2	50	16	240	139	120	25.7	233.6	285	A	2348	HO URE B07	£239.20	HO URF B07	£319.84

VR ANGLE SEAT CHECK VALVES

with Metric series plain female ends for solvent welding

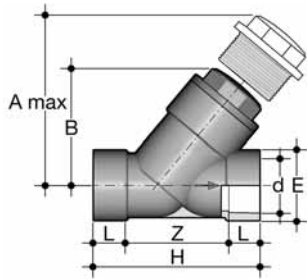

d	DN	PN	A max	B	E	L	Z	H	K	Fig.	g	Product Code	List Price (£)	Product Code	List Price (£)
												EPDM		FPM	
75	65	10	300	179	104	44	155	243	96	B	3485	HO VRE 312	£238.98	HO VRF 312	£351.40
90	80	6	325	192	116	51	160	262	105	B	4530	HO VRE 313	£316.04	HO VRF 313	£464.70
110	100	6	385	231	138	61	203	325	-	C	7170	HO VRE 314	£388.43	HO VRF 314	£490.40

with BS parallel threaded female ends

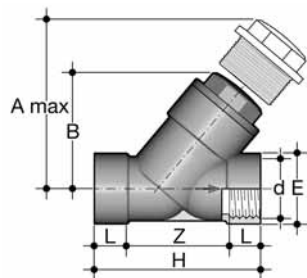

d	DN	PN	A max	B	E	L	Z	H	K	Fig.	g	Product Code	List Price (£)	Product Code	List Price (£)
												EPDM		FPM	
2 1/2	65	10	300	179	104	30.2	182.6	243	96	B	3485	HO VRE B08	£239.20	HO VRF B08	£351.72
3	80	6	325	192	116	33.3	195.4	262	105	B	4520	HO VRE B09	£378.96	HO VRF B09	£557.24
4	100	6	385	231	138	39.3	246.4	325	-	-	6965	HO VRE B10	£511.39	HO VRF B10	£751.97

RV SEDIMENT STRAINERS

with unionised BS series plain female ends for solvent welding, grey PVC-U

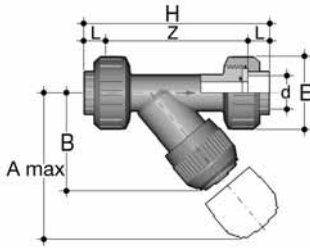

d	DN	PN	A max	B	E	L	Z	H	Fig.	g	Product Code	List Price (£)	Product Code	List Price (£)
											EPDM		FPM	
3/8	10	16	125	72	55	14	107	135	A	203	HO UVE 101	£33.36	HO UVF 101	£42.89
1/2	15	16	125	72	55	16	103	135	A	211	HO UVE 102	£34.10	HO UVF 102	£46.20
3/4	20	16	145	84	66	19	120	158	A	358	HO UVE 103	£37.14	HO UVF 103	£51.48
1	25	16	165	95	75	22	132	176	A	526	HO UVE 104	£50.26	HO UVF 104	£67.00
1 1/4	32	16	190	111	87	26	155	207	A	733	HO UVE 105	£60.79	HO UVF 105	£75.75
1 1/2	40	16	210	120	100	31	181	243	A	1095	HO UVE 106	£83.78	HO UVF 106	£121.18
2	50	16	240	139	120	38	222	298	A	1843	HO UVE 107	£117.88	HO UVF 107	£158.80

with unionised Metric series plain female ends for solvent welding, grey PVC-U

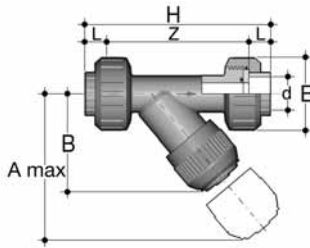

d	DN	PN	A max	B	E	L	Z	H	Fig.	g	Product Code	List Price (£)	Product Code	List Price (£)
											EPDM		FPM	
16	10	16	125	72	55	14	107	135	A	203	HO UVE 305	£33.37	HO UVF 305	£42.89
20	15	16	125	72	55	16	103	135	A	211	HO UVE 306	£34.10	HO UVF 306	£46.20
25	20	16	145	84	66	19	120	158	A	358	HO UVE 307	£37.82	HO UVF 307	£51.48
32	25	16	165	95	75	22	132	176	A	526	HO UVE 308	£49.19	HO UVF 308	£67.00
40	32	16	190	111	87	26	155	207	A	733	HO UVE 309	£60.86	HO UVF 309	£75.75
50	40	16	210	120	100	31	181	243	A	1095	HO UVE 310	£81.73	HO UVF 310	£121.18
63	50	16	240	139	120	38	222	298	A	1843	HO UVE 311	£117.88	HO UVF 311	£158.80

with unionised BS parallel threaded female ends, grey PVC-U

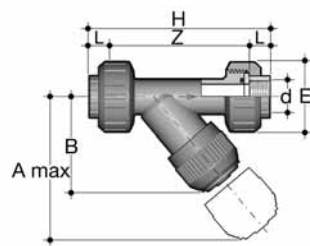

d	DN	PN	A max	B	E	L	Z	H	Fig.	g	Product Code	List Price (£)	Product Code	List Price (£)
											EPDM		FPM	
3/8	10	16	125	72	55	11.4	112.2	135	A	206	HO UVE B01	£35.88	HO UVF B01	£46.14
1/2	15	16	125	72	55	15.0	112.0	142	A	210	HO UVE B02	£36.62	HO UVF B02	£49.61
3/4	20	16	145	84	66	16.3	126.4	159	A	355	HO UVE B03	£41.41	HO UVF B03	£56.39
1	25	16	165	95	75	19.1	144.8	183	A	522	HO UVE B04	£55.32	HO UVF B04	£73.75
1 1/4	32	16	190	111	87	21.4	171.2	214	A	742	HO UVE B05	£76.00	HO UVF B05	£84.23
1 1/2	40	16	210	120	100	21.4	192.2	235	A	1106	HO UVE B06	£94.94	HO UVF B06	£137.33
2	50	16	240	139	120	25.7	233.6	285	A	1873	HO UVE B07	£137.80	HO UVF B07	£185.65

RV SEDIMENT STRAINERS

with unionised BS series female ends for solvent welding, transparent PVC-U

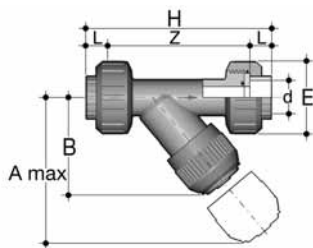

d	DN	PN	A max	B	E	L	Z	H	Fig	g	Product Code	List Price (£)	Product Code	List Price (£)
											EPDM		FPM	
3/8	10	16	125	72	55	14	107	135	A	203	HO UTE 101	£33.36	HO UTF 101	£42.89
1/2	15	16	125	72	55	16	103	135	A	211	HO UTE 102	£34.10	HO UTF 102	£46.20
3/4	20	16	145	84	66	19	120	158	A	358	HO UTE 103	£37.82	HO UTF 103	£51.48
1	25	16	165	95	75	22	132	176	A	526	HO UTE 104	£50.26	HO UTF 104	£67.00
1 1/4	32	10	190	111	87	26	155	207	A	733	HO UTE 105	£68.35	HO UTF 105	£75.75
1 1/2	40	10	210	120	100	31	181	243	A	1095	HO UTE 106	£83.77	HO UTF 106	£121.18
2	50	10	240	139	120	38	222	298	A	1843	HO UTE 107	£117.88	HO UTF 107	£158.80

with unionised Metric series plain female ends for solvent welding, transparent PVC-U

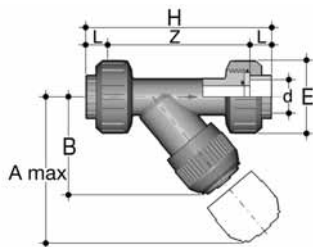

d	DN	PN	A max	B	E	L	Z	H	Fig	g	Product Code	List Price (£)	Product Code	List Price (£)
											EPDM		FPM	
16	10	16	125	72	55	14	107	135	A	203	HO UTE 305	£32.48	HO UTF 305	£41.77
20	15	16	125	72	55	16	103	135	A	211	HO UTE 306	£34.16	HO UTF 306	£46.27
25	20	16	145	84	66	19	120	158	A	358	HO UTE 307	£41.47	HO UTF 307	£56.46
32	25	16	165	95	75	22	132	176	A	526	HO UTE 308	£52.97	HO UTF 308	£70.62
40	32	10	190	111	87	26	155	207	A	733	HO UTE 309	£69.65	HO UTF 309	£77.17
50	40	10	210	120	100	31	181	243	A	1095	HO UTE 310	£90.11	HO UTF 310	£130.36
63	50	10	240	139	120	38	222	298	A	1843	HO UTE 311	£113.10	HO UTF 311	£152.36

with unionised BS parallel threaded female ends, transparent PVC-U

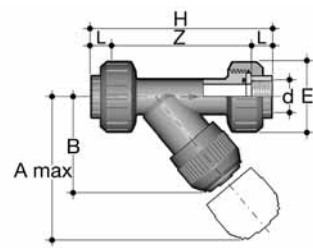

d	DN	PN	A max	B	E	L	Z	H	Fig.	g	Product Code	List Price (£)	Product Code	List Price (£)
											EPDM		FPM	
3/8	10	16	125	72	55	11.4	112.2	135	A	206	HO UTE B01	£34.77	HO UTF B01	£45.01
1/2	15	16	125	72	55	15.0	112.0	142	A	210	HO UTE B02	£36.56	HO UTF B02	£49.70
3/4	20	16	145	84	66	16.3	126.4	159	A	355	HO UTE B03	£44.38	HO UTF B03	£61.37
1	25	16	165	95	75	19.1	144.8	183	A	522	HO UTE B04	£56.69	HO UTF B04	£77.37
1 1/4	32	10	190	111	87	21.4	171.2	214	A	742	HO UTE B05	£74.51	HO UTF B05	£85.65
1 1/2	40	10	210	120	100	21.4	192.2	235	A	1106	HO UTE B06	£96.43	HO UTF B06	£146.50
2	50	10	240	139	120	25.7	233.6	285	A	1873	HO UTE B07	£121.02	HO UTF B07	£179.21

RV SEDIMENT STRAINERS

with Metric series plain female ends for solvent welding, grey PVC-U

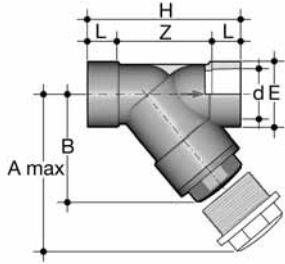

d	DN	PN	A	B	E	L	Z	H	K	Fig	g	Product Code	List Price (£)	Product Code	List Price (£)
max												EPDM		FPM	
75	65	10	300	179	104	44	155	243	96	B	2385	HO RVE 312	£135.08	HO RVF 312	£162.09
90	80	6	325	192	116	51	160	262	105	B	2975	HO RVE 313	£189.62	HO RVF 313	£184.77
110	100	6	385	231	138	61	203	325	-	C	4610	HO RVE 314	£308.25	HO RVF 314	£364.29

with Metric series plain female ends for solvent welding, transparent PVC-U

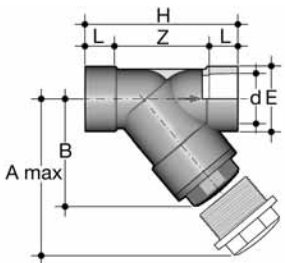

d	DN	PN	A	B	E	L	Z	H	K	Fig	g	Product Code	List Price (£)	Product Code	List Price (£)
max												EPDM		FPM	
75	65	6	300	179	104	44	155	243	96	B	2385	HO RTE 312	£168.75	HO RTF 312	£202.49
90	80	4	325	192	116	51	160	262	105	B	2975	HO RTE 313	£189.40	HO RTF 313	£227.49
110	100	4	385	231	138	61	203	325	-	C	4610	HO RTE 314	£308.18	HO RTF 314	£369.66

with BS parallel threaded female ends, grey PVC-U

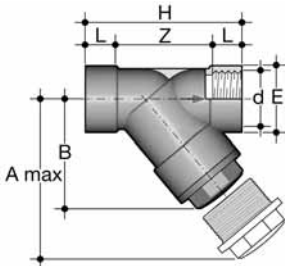

d	DN	PN	A	B	E	L	Z	H	K	Fig	g	Product Code	List Price (£)	Product Code	List Price (£)
max												EPDM		FPM	
2 1/2	65	10	300	179	104	30.2	182.6	243	96	B	2385	HO RVE B08	£168.75	HO RVF B08	£202.49
3	80	6	325	192	116	33.3	195.4	262	105	B	2965	HO RVE B09	£189.57	HO RVF B09	£227.49
4	100	6	385	231	138	39.3	246.4	325	-	C	4405	HO RVE B10	£308.18	HO RVF B10	£369.81

with BS parallel threaded female ends, transparent PVC-U

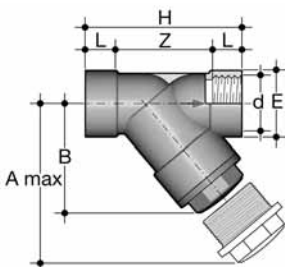

d	DN	PN	A	B	E	L	Z	H	K	Fig	g	Product Code	List Price (£)	Product Code	List Price (£)
max												EPDM		FPM	
2 1/2	65	6	300	179	104	30.2	182.6	243	96	B	2385	HO RTE B08	£180.55	HO RTF B08	£216.68
3	80	4	325	192	116	33.3	195.4	262	105	B	2965	HO RTE B09	£202.66	HO RTF B09	£243.20
4	100	4	385	231	138	39.3	246.4	325	-	C	4405	HO RTE B10	£329.75	HO RTF B10	£395.70

VV ANGLE SEAT VALVES

with unionised BS series plain female ends for solvent welding

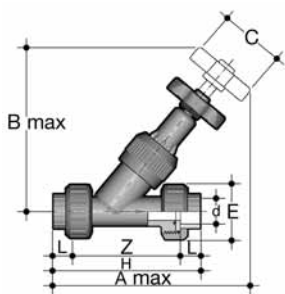

d	DN	PN	B max	C	E	H	L	Z	A max	Fig.	g	Product Code	List Price (£)
EPDM													
3/8	10	16	124	60	55	135	14	107	170	A	238	HO VUE 101	£49.13
1/2	15	16	124	60	55	135	16	103	173	A	251	HO VUE 102	£53.44
3/4	20	16	146	60	66	158	19	120	197	A	413	HO VUE 103	£57.41
1	25	16	173	70	75	176	22	132	233	A	621	HO VUE 104	£70.01
1 1/4	32	10	195	85	87	207	26	155	258	A	903	HO VUE 105	£91.35
1 1/2	40	10	222	105	100	243	31	181	295	A	1320	HO VUE 106	£116.97
2	50	10	269	130	120	298	38	222	359	A	2238	HO VUE 107	£160.25

with unionised Metric series plain female ends for solvent welding

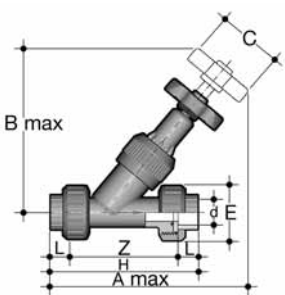

d	DN	PN	B max	C	E	H	L	Z	A max	Fig.	g	Product Code	List Price (£)
EPDM													
16	10	16	124	60	55	135	14	107	170	A	238	HO VUE 305	£49.13
20	15	16	124	60	55	135	16	103	173	A	251	HO VUE 306	£53.44
25	20	16	146	60	66	158	19	120	197	A	413	HO VUE 307	£57.41
32	25	16	173	70	75	176	22	132	233	A	621	HO VUE 308	£70.01
40	32	10	195	85	87	207	26	155	258	A	903	HO VUE 309	£91.34
50	40	10	222	105	100	243	31	181	295	A	1320	HO VUE 310	£116.96
63	50	10	269	130	120	298	38	222	359	A	2238	HO VUE 311	£160.26

with unionised BS parallel threaded female ends

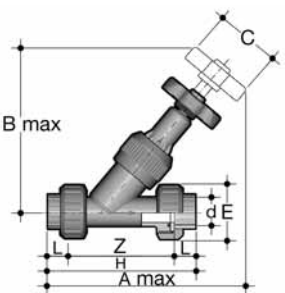

d	DN	PN	B max	C	E	H	L	Z	A max	Fig.	g	Product Code	List Price (£)
EPDM													
3/8	10	16	124	60	55	135	11.4	112.2	170	A	238	HO VUE B01	£51.64
1/2	15	16	124	60	55	142	15.0	112.0	173	A	251	HO VUE B02	£55.96
3/4	20	16	146	60	66	159	16.3	126.4	197	A	413	HO VUE B03	£61.01
1	25	16	173	70	75	183	19.1	144.8	223	A	621	HO VUE B04	£75.07
1 1/4	32	10	195	85	87	214	21.4	171.2	258	A	903	HO VUE B05	£99.00
1 1/2	40	10	222	105	100	235	21.4	192.2	295	A	1320	HO VUE B06	£128.13
2	50	10	269	130	120	285	25.7	233.6	359	A	2238	HO VUE B07	£180.18

with Metric series plain female ends for solvent welding

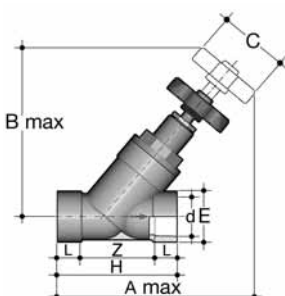

d	DN	PN	B max	C	E	L	Z	H	A max	K	Fig.	g	Product Code	List Price (£)
EPDM														
75	65	10	326	130	104.0	243	44	155	374	96	B	3190	HO VVE 312	£237.42
90	80	6	368	174	115.5	262	51	160	423	105	B	4110	HO VVE 313	£349.51
110	100	6	420	174	138.0	325	61	203	498	-	C	6040	HO VVE 314	£435.91

PR PRESSURE RELIEF VALVES

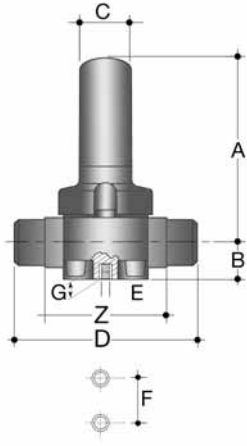

with BS series male ends for solvent welding

d	Z	A	B	C	D	E	F	G	kg	Product Code	List Price (£)	Product Code	List Price (£)
										EPDM	FPM	EPDM	FPM
1/2	92	143	20.5	35	124	M6	25	12	0.7	HO PRE 202	£274.03	HO PRF 202	£314.83
3/4	106	143	20.5	35	144	M6	25	12	0.7	HO PRE 203	£295.68	HO PRF 203	£325.25
1	108	143	25	35	154	M6	25	12	0.7	HO PRE 204	£318.17	HO PRF 204	£349.99
1 1/4	120	204	36	50	174	M8	44.5	16	1.5	HO PRE 205	£374.81	HO PRF 205	£408.99
1 1/2	130	204	39.5	50	194	M8	44.5	16	1.5	HO PRE 206	£433.95	HO PRF 206	£477.34
2	146	219	49	50	224	M8	44.5	16	2.4	HO PRE 207	£499.73	HO PRF 207	£549.71

with Metric series male ends for solvent welding

d	Z	A	B	C	D	E	F	G	kg	Product Code	List Price (£)	Product Code	List Price (£)
										EPDM	FPM	EPDM	FPM
20	92	143	20.5	35	124	M6	25	12	0.7	HO PRE 406	£274.00	HO PRF 406	£301.40
25	106	143	20.5	35	144	M6	25	12	0.7	HO PRE 407	£295.81	HO PRF 407	£325.37
32	108	143	25	35	154	M6	25	12	0.7	HO PRE 408	£317.59	HO PRF 408	£349.35
40	120	204	36	50	174	M8	44.5	16	1.5	HO PRE 409	£376.75	HO PRF 409	£414.42
50	130	204	39.5	50	194	M8	44.5	16	1.5	HO PRE 410	£432.79	HO PRF 410	£476.07
63	146	219	49	50	224	M8	44.5	16	2.4	HO PRE 411	£498.18	HO PRF 411	£548.00

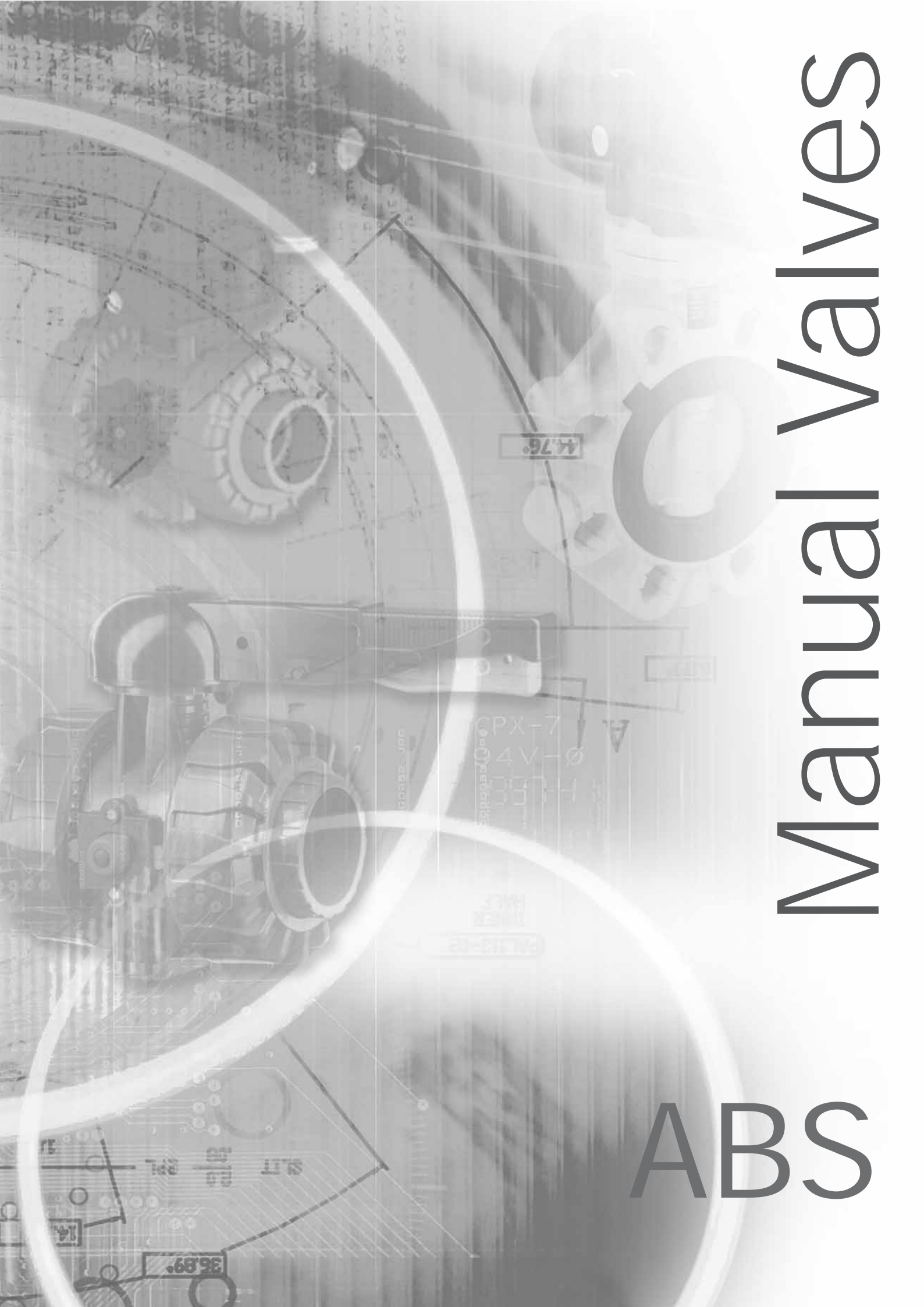

Manual Valves

ABS

VKD DOUBLE UNION BALL VALVES ($\frac{3}{8}$ "/d16 to 2"/d63)

with BS series plain female ends - Standard valve

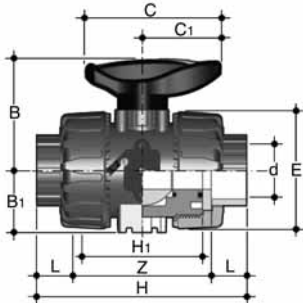

d	DN	PN	L	Z	H	H ₁	E	B	B ₁	C	C ₁	g	Product Code	List Price (£)	Product Code	List Price (£)
													EPDM		FPM	
$\frac{3}{8}$	10	16	14.5	74	103	65	54	54	29	67	40	195	HO DKA 101	£39.68	HO DKB 101	£49.04
$\frac{1}{2}$	15	16	16.5	70	103	65	54	54	29	67	40	195	HO DKA 102	£41.26	HO DKB 102	£50.12
$\frac{3}{4}$	20	16	19	77	115	70	65	65	34.5	85	49	315	HO DKA 103	£49.04	HO DKB 103	£58.22
1	25	16	22.5	83	128	78	73	69.5	39	85	49	435	HO DKA 104	£58.53	HO DKB 104	£73.01
$1\frac{1}{4}$	32	16	26	94	146	88	86	82.5	46	108	64	655	HO DKA 105	£75.04	HO DKB 105	£88.57
$1\frac{1}{2}$	40	16	30	104	164	93	98	89	52	108	64	880	HO DKA 106	£96.68	HO DKB 106	£116.93
2	50	16	36	127	199	111	122	108	62	134	76	156	HO DKA 107	£123.00	HO DKB 107	£157.87

with BS series plain female ends - Valve, with lockable handle

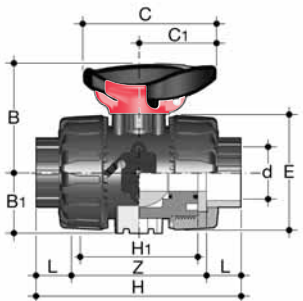

d	DN	PN	L	Z	H	H ₁	E	B	B ₁	C	C ₁	g	Product Code	List Price (£)	Product Code	List Price (£)
													EPDM		FPM	
$\frac{3}{8}$	10	16	14.5	74	103	65	54	54	29	67	40	195	HO DLA 101	£54.17	HO DLB 101	£63.53
$\frac{1}{2}$	15	16	16.5	70	103	65	54	54	29	67	40	195	HO DLA 102	£55.74	HO DLB 102	£64.61
$\frac{3}{4}$	20	16	19	77	115	70	65	65	34.5	85	49	315	HO DLA 103	£65.23	HO DLB 103	£74.41
1	25	16	22.5	83	128	78	73	69.5	39	85	49	435	HO DLA 104	£74.72	HO DLB 104	£89.20
$1\frac{1}{4}$	32	16	26	94	146	88	86	82.5	46	108	64	655	HO DLA 105	£93.79	HO DLB 105	£107.31
$1\frac{1}{2}$	40	16	30	104	164	93	98	89	52	108	64	880	HO DLA 106	£115.43	HO DLB 106	£135.67
2	50	16	36	127	199	111	122	108	62	134	76	156	HO DLA 107	£143.11	HO DLB 107	£177.98

with Metric series plain female ends - Standard valve

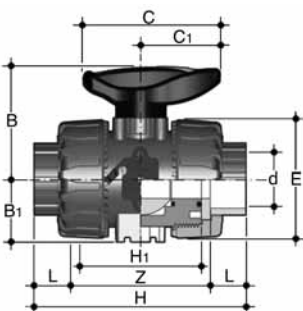

d	DN	PN	L	Z	H	H ₁	E	B	B ₁	C	C ₁	g	Product Code	List Price (£)	Product Code	List Price (£)
													EPDM		FPM	
16	10	16	14	75	103	65	54	54	29	67	40	195	HO DKA 305	£39.68	HO DKB 305	£49.04
20	15	16	16	71	103	65	54	54	29	67	40	195	HO DKA 306	£41.26	HO DKB 306	£50.12
25	20	16	19	77	115	70	65	65	34.5	85	49	315	HO DKA 307	£49.04	HO DKB 307	£58.22
32	25	16	22	84	128	78	73	69.5	39	85	49	435	HO DKA 308	£58.53	HO DKB 308	£73.01
40	32	16	26	94	146	88	86	82.5	46	108	64	655	HO DKA 309	£75.04	HO DKB 309	£88.57
50	40	16	31	102	164	93	98	89	52	108	64	880	HO DKA 310	£96.68	HO DKB 310	£116.93
63	50	16	38	123	199	111	122	108	62	134	76	156	HO DKA 311	£123.00	HO DKB 311	£157.87

with Metric series plain female ends - Valve, with lockable handle

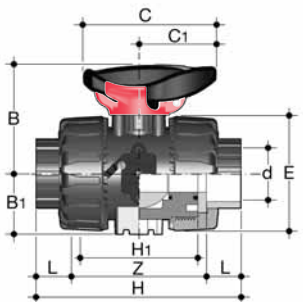

d	DN	PN	L	Z	H	H ₁	E	B	B ₁	C	C ₁	g	Product Code	List Price (£)	Product Code	List Price (£)
													EPDM		FPM	
16	10	16	14	75	103	65	54	54	29	67	40	195	HO DLA 305	£54.17	HO DLB 305	£63.53
20	15	16	16	71	103	65	54	54	29	67	40	195	HO DLA 306	£55.74	HO DLB 306	£64.61
25	20	16	19	77	115	70	65	65	34.5	85	49	315	HO DLA 307	£65.23	HO DLB 307	£74.41
32	25	16	22	84	128	78	73	69.5	39	85	49	435	HO DLA 308	£74.72	HO DLB 308	£89.20
40	32	16	26	94	146	88	86	82.5	46	108	64	655	HO DLA 309	£93.79	HO DLB 309	£107.31
50	40	16	31	102	164	93	98	89	52	108	64	880	HO DLA 310	£115.43	HO DLB 310	£135.67
63	50	16	38	123	199	111	122	108	62	134	76	156	HO DLA 311	£143.11	HO DLB 311	£177.98

See page 79 for a full list of VKD accessories.

VKD DOUBLE UNION BALL VALVES (1/2" to 2")

with BSP parallel threaded female ends - Standard valve

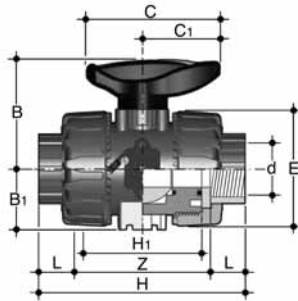

d	DN	PN	L	Z	H	H ₁	E	B	B ₁	C	C ₁	g	Product Code	List Price (£)	Product Code	List Price (£)
													EPDM		FPM	
1/2	15	16	16.5	70	103	65	54	54	29	67	40	195	HO DKA B02	£48.73	HO DKB B02	£58.53
3/4	20	16	19	77	115	70	65	65	34.5	85	49	315	HO DKA B03	£57.91	HO DKB B03	£69.44
1	25	16	22.5	83	128	78	73	69.5	39	85	49	435	HO DKA B04	£70.52	HO DKB B04	£88.12
1 1/4	32	16	26	94	146	88	86	82.5	46	108	64	655	HO DKA B05	£90.60	HO DKB B05	£107.26
1 1/2	40	16	30	104	164	93	98	89	52	108	64	880	HO DKA B06	£118.16	HO DKB B06	£138.25
2	50	16	36	127	199	111	122	108	62	134	76	156	HO DKA B07	£151.78	HO DKB B07	£189.64

with BSP parallel threaded female ends - Valve, with lockable handle

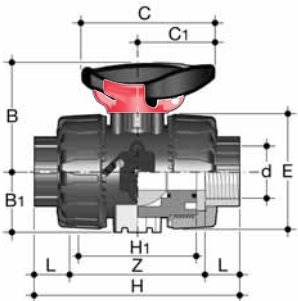

d	DN	PN	L	Z	H	H ₁	E	B	B ₁	C	C ₁	g	Product Code	List Price (£)	Product Code	List Price (£)
													EPDM		FPM	
1/2	15	16	16.5	70	103	65	54	54	29	67	40	195	HO DLA B02	£63.21	HO DLB B02	£73.01
3/4	20	16	19	77	115	70	65	65	34.5	85	49	315	HO DLA B03	£74.10	HO DLB B03	£85.62
1	25	16	22.5	83	128	78	73	69.5	39	85	49	435	HO DLA B04	£86.71	HO DLB B04	£104.31
1 1/4	32	16	26	94	146	88	86	82.5	46	108	64	655	HO DLA B05	£109.34	HO DLB B05	£126.01
1 1/2	40	16	30	104	164	93	98	89	52	108	64	880	HO DLA B06	£136.91	HO DLB B06	£157.00
2	50	16	36	127	199	111	122	108	62	134	76	156	HO DLA B07	£171.89	HO DLB B07	£209.75

VKD 2-WAY BALL VALVES (2 1/2"/d75 to 4"/d110)

with BS series plain female ends

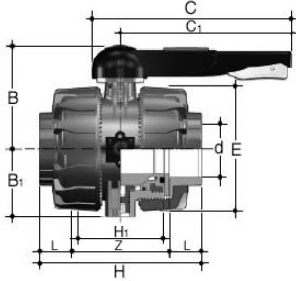

d	DN	PN	Z	L	H	H ₁	E	B	B ₁	C	C ₁	g	Product Code	List Price (£)	Product Code	List Price (£)
													EPDM		FPM	
2 1/2	65	16	147	44	235	133	164	164	87	225	175	4380	HO DKA 312	£258.24	HO DKB 312	£346.42
3	80	16	168	51	270	149	203	177	105	327	272	7200	HO DKA 109	£327.53	HO DKB 109	£415.70
4	100	16	182	63	308	167	238	195	129	385	330	11141	HO DKA 110	£453.50	HO DKB 110	£535.38

with Metric series plain female

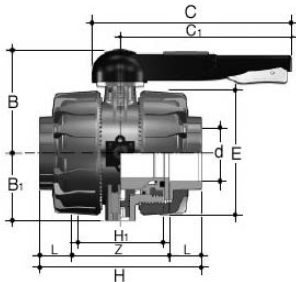

d	DN	PN	Z	L	H	H ₁	E	B	B ₁	C	C ₁	g	Product Code	List Price (£)	Product Code	List Price (£)
													EPDM		FPM	
75	65	16	147	44	235	133	164	164	87	225	175	4380	HO DKA 312	£258.24	HO DKB 312	£346.42
90	80	16	168	51	270	149	203	177	105	327	272	7200	HO DKA 313	£327.53	HO DKB 313	£415.70
110	100	16	186	61	308	167	238	195	129	385	330	11141	HO DKA 314	£453.50	HO DKB 314	£535.38

EV BALL VALVES

BS series

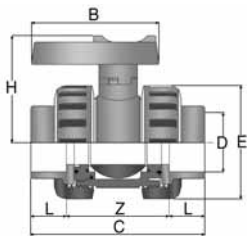

d	DN	PN	L	Z	C	E	H	B	g	Product Code	List Price (£)	
											EPDM	
1/2	15	10	17	47	81	50	50	57	95	HO EVA 102	£18.86	
3/4	20	10	19	57	95	59	55	66	156	HO EVA 103	£22.22	
1	25	10	22	61	105	68	66.5	75	228	HO EVA 104	£27.11	
1 1/4	32	10	26	72	124	80	79.5	90	334	HO EVA 105	£34.86	
1 1/2	40	10	31	84	146	96	93	103	540	HO EVA 106	£44.68	
2	50	10	38	96	172	116	107	121	844	HO EVA 107	£55.84	

Metric series

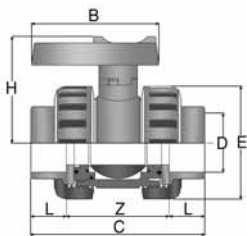

d	DN	PN	L	Z	C	E	H	B	g	Product Code	List Price (£)	
											EPDM	
20	15	10	17	47	81	50	50	57	95	HO EVA 306	£18.86	
25	20	10	19	57	95	59	55	66	156	HO EVA 307	£22.22	
32	25	10	22	61	105	68	66.5	75	228	HO EVA 308	£27.11	
40	32	10	26	72	124	80	79.5	90	334	HO EVA 309	£34.86	
50	40	10	31	84	146	96	93	103	540	HO EVA 310	£44.68	
63	50	10	38	96	172	116	107	121	844	HO EVA 311	£55.84	

BSP parallel threaded

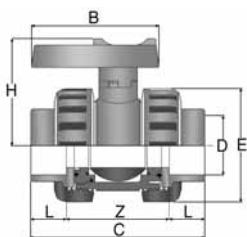

d	DN	PN	L	Z	C	E	H	B	g	Product Code	List Price (£)	
											EPDM	
1/2	15	10	17	47	81	50	50	57	95	HO EVA B02	£21.33	
3/4	20	10	19	57	95	59	55	66	156	HO EVA B03	£24.88	
1	25	10	22	61	105	68	66.5	75	228	HO EVA B04	£29.86	
1 1/4	32	10	26	72	124	80	79.5	90	334	HO EVA B05	£39.39	
1 1/2	40	10	31	84	146	96	93	103	540	HO EVA B06	£49.44	
2	50	10	38	96	172	116	107	121	844	HO EVA B07	£61.35	

TKD 3-WAY BALL VALVES



with BS series plain female ends for solvent welding (T Port)

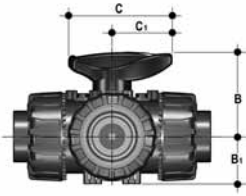

d	DN	PN	H	Z	C	C1	B	B1	g	Product Code	List Price (£)	Product Code	List Price (£)
										EPDM		FPM	
1/2	15	16	125	95	67	40	54	29	310	HO TTA 102	£81.51	HO TTB 102	£105.81
3/4	20	16	146	114	85	49	65	34.5	550	HO TTA 103	£91.17	HO TTB 103	£119.65
1	25	16	166	129	85	49	65.9	39	790	HO TTA 104	£107.56	HO TTB 104	£144.20
1 1/4	32	16	195.5	151	108	64	82.5	46	1275	HO TTA 105	£130.42	HO TTB 105	£174.90
1 1/2	40	16	211	166	108	64	89	52	1660	HO TTA 106	£141.43	HO TTB 106	£220.06
2	50	16	253.5	199	134	76	108	62	2800	HO TTA 107	£182.30	HO TTB 107	£281.08

with Metric series plain female ends for solvent welding (T Port)

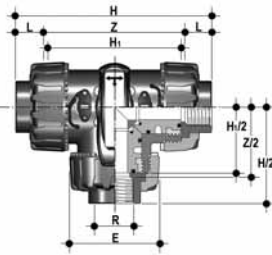

d	DN	PN	H	Z	C	C1	B	B1	g	Product Code	List Price (£)	Product Code	List Price (£)
										EPDM		FPM	
20	15	16	118	86	67	40	54	29	310	HO TTA 306	£81.51	HO TTB 306	£105.81
25	20	16	145	107	85	49	65	34.5	550	HO TTA 307	£91.17	HO TTB 307	£119.65
32	25	16	160	116	85	49	65.9	39	790	HO TTA 308	£107.56	HO TTB 308	£144.20
40	32	16	188.5	136.5	108	64	82.5	46	1275	HO TTA 309	£130.42	HO TTB 309	£174.90
50	40	16	219	157	108	64	89	52	1660	HO TTA 310	£141.43	HO TTB 310	£220.06
63	50	16	266.5	190.5	134	76	108	62	2800	HO TTA 311	£182.30	HO TTB 311	£281.08

with BS series plain female ends for solvent welding (L Port)

d	DN	PN	H	Z	C	C1	B	B1	g	Product Code	List Price (£)	Product Code	List Price (£)
										EPDM		FPM	
1/2	15	16	125	95	67	40	54	29	310	HO LTA 102	£81.51	HO LTB 102	£105.81
3/4	20	16	146	114	85	49	65	34.5	550	HO LTA 103	£91.17	HO LTB 103	£119.65
1	25	16	166	129	85	49	65.9	39	790	HO LTA 104	£107.56	HO LTB 104	£144.20
1 1/4	32	16	195.5	151	108	64	82.5	46	1275	HO LTA 105	£130.42	HO LTB 105	£174.90
1 1/2	40	16	211	166	108	64	89	52	1660	HO LTA 106	£141.43	HO LTB 106	£220.06
2	50	16	253.5	199	134	76	108	62	2800	HO LTA 107	£182.30	HO LTB 107	£281.08

with Metric series plain female ends for solvent welding (L Port)

d	DN	PN	H	Z	C	C1	B	B1	g	Product Code	List Price (£)	Product Code	List Price (£)
										EPDM		FPM	
20	15	16	118	86	67	40	54	29	310	HO LTA 306	£81.51	HO LTB 306	£105.81
25	20	16	145	107	85	49	65	34.5	550	HO LTA 307	£91.17	HO LTB 307	£119.65
32	25	16	160	116	85	49	65.9	39	790	HO LTA 308	£107.56	HO LTB 308	£144.20
40	32	16	188.5	136.5	108	64	82.5	46	1275	HO LTA 309	£130.42	HO LTB 309	£174.90
50	40	16	219	157	108	64	89	52	1660	HO LTA 310	£141.43	HO LTB 310	£220.06
63	50	16	266.5	190.5	134	76	108	62	2800	HO LTA 311	£182.30	HO LTB 311	£281.08

See page 79 for a full list of TKD accessories.

ABS imperial & metric MANUAL VALVES

FK BUTTERFLY VALVES - GRPP BODY WITH ABS DISC

Lever operated - PN10/ANSI/BS10

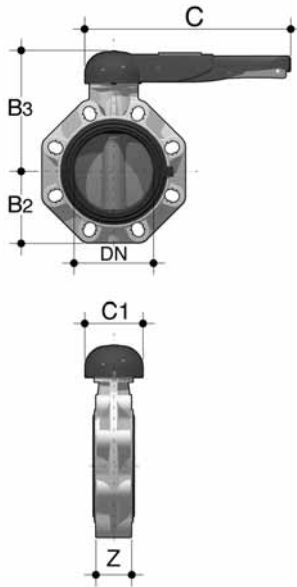

d	DN	PN	B2	B3	C	C1	Z	g	U	Product Code	List Price (£)	Product Code	List Price (£)
										EPDM		FPM	
1½	40	16	60	137	175	100	33	900	4	H0 FKA 106	£123.64	H0 FKB 106	£149.51
2	50	16	70	143	175	100	43	1080	4	H0 FKA 107	£130.42	H0 FKB 107	£158.42
2½	65	10	80	164	272	110	46	1470	4	H0 FKA 108	£143.23	H0 FKB 108	£175.93
3	80	10	93	178	272	110	49	1870	8	H0 FKA 109	£157.85	H0 FKB 109	£184.48
4	100	10	107	192	272	110	56	2220	8	H0 FKA 110	£191.19	H0 FKB 110	£220.30
5	125	10	120	212	330	110	64	3100	8	H0 FKA 111	£247.53	H0 FKB 111	£277.11
6	150	10	134	225	330	110	70	3850	8	H0 FKA 112	£304.37	H0 FKB 112	£340.17
8	200	10	161	272	420	122	71	6750	8	H0 FKA 113	£453.03	H0 FKB 113	£496.63

Lever operated - LUGGED BS 4504, PN10

d	DN	PN	B2	B3	C	C1	Z	g	U	Product Code	List Price (£)	Product Code	List Price (£)
										EPDM		FPM	
2½	65	10	80	164	272	110	46	1470	4	H0 FKA F08	£223.02	H0 FKB F08	£301.90
3	80	10	93	178	272	110	49	1870	8	H0 FKA F09	£258.92	H0 FKB F09	£347.97
4	100	10	107	192	272	110	56	2220	8	H0 FKA F10	£318.70	H0 FKB F10	£439.32
5	125	10	120	212	330	110	64	3100	8	H0 FKA F11	£404.99	H0 FKB F11	£559.82
6	150	10	134	225	330	110	70	3850	8	H0 FKA F12	£492.12	H0 FKB F12	£680.15
8	200	10	161	272	420	122	71	6750	8	H0 FKA F13	£611.28	H0 FKB F13	£883.23

Suitable for end of line applications

Lever operated - LUGGED ANSI 150

d	DN	PN	B2	B3	C	C1	Z	g	U	Product Code	List Price (£)	Product Code	List Price (£)
										EPDM		FPM	
2½	65	10	80	164	272	110	46	1470	4	H0 FKA X08	£254.93	H0 FKB X08	£333.81
3	80	10	93	178	272	110	49	1870	8	H0 FKA X09	£293.42	H0 FKB X09	£382.46
4	100	10	107	192	272	110	56	2220	8	H0 FKA X10	£361.39	H0 FKB X10	£482.00
5	125	10	120	212	330	110	64	3100	8	H0 FKA X11	£458.98	H0 FKB X11	£613.80
6	150	10	134	225	330	110	70	3850	8	H0 FKA X12	£558.02	H0 FKB X12	£746.04
8	200	10	161	272	420	122	71	6750	8	H0 FKA X13	£698.24	H0 FKB X13	£970.19

Suitable for end of line applications

FK BUTTERFLY VALVES - GRPP BODY WITH ABS DISC

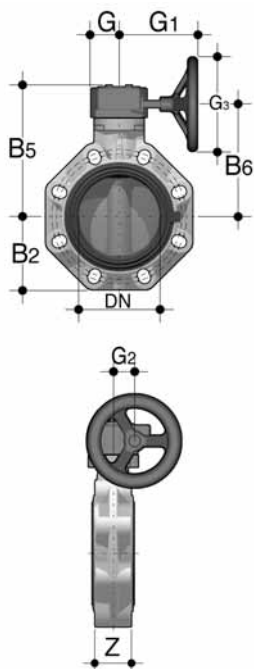

Gear box operated - PN10/ANSI/BS10

d	DN	PN	B2	B5	B6	G	G1	G2	G3	Z	g	U	Product Code	List Price (£)	Product Code	List Price (£)
													EPDM		FPM	
2 1/2	65	10	80	174	146	48	135	39	125	46	2400	4	HV FKA 108	£354.60	HV FKB 108	£387.29
3	80	10	93	188	160	48	135	39	125	49	2800	8	HV FKA 109	£369.23	HV FKB 109	£395.86
4	100	10	107	202	174	48	135	39	125	56	3150	8	HV FKA 110	£402.55	HV FKB 110	£431.67
5	125	10	120	222	194	48	144	39	200	64	4450	8	HV FKA 111	£458.90	HV FKB 111	£488.48
6	150	10	134	235	207	48	144	39	200	70	5200	8	HV FKA 112	£515.74	HV FKB 112	£551.54
8	200	10	161	287	256	65	204	60	200	71	9300	8	HV FKA 113	£711.61	HV FKB 113	£755.20
10	250	10	210	317	281	88	236	76	250	114	18600	12	HV FKA 114	£1,233.64	HV FKB 114	£2,106.53
12	300	8	245	374	338	88	236	76	250	114	25600	12	HV FKA 115	£1,330.75	HV FKB 115	£2,280.72

Gear box operated - LUGGED BS 4504, PN10

d	DN	PN	B2	B5	B6	G	G1	G2	G3	Z	g	U	Product Code	List Price (£)	Product Code	List Price (£)
													EPDM		FPM	
2 1/2	65	10	80	174	146	48	135	39	125	46	2400	4	HV FKA F08	£434.40	HV FKB F08	£513.27
3	80	10	93	188	160	48	135	39	125	49	2800	8	HV FKA F09	£470.29	HV FKB F09	£559.34
4	100	10	107	202	174	48	135	39	125	56	3150	8	HV FKA F10	£530.07	HV FKB F10	£650.69
5	125	10	120	222	194	48	144	39	200	64	4450	8	HV FKA F11	£616.37	HV FKB F11	£771.19
6	150	10	134	235	207	48	144	39	200	70	5200	8	HV FKA F12	£703.49	HV FKB F12	£891.52
8	200	10	161	287	256	65	204	60	200	71	9300	8	HV FKA F13	£869.86	HV FKB F13	£1,141.66

Suitable for end of line applications

Gear box operated - LUGGED ANSI 150

d	DN	PN	B2	B5	B6	G	G1	G2	G3	Z	g	U	Product Code	List Price (£)	Product Code	List Price (£)
													EPDM		FPM	
2 1/2	65	10	80	174	146	48	135	39	125	46	2400	4	HV FKA X08	£466.30	HV FKB X08	£545.18
3	80	10	93	188	160	48	135	39	125	49	2800	8	HV FKA X09	£504.79	HV FKB X09	£593.83
4	100	10	107	202	174	48	135	39	125	56	3150	8	HV FKA X10	£572.76	HV FKB X10	£693.38
5	125	10	120	222	194	48	144	39	200	64	4450	8	HV FKA X11	£670.35	HV FKB X11	£825.17
6	150	10	134	235	207	48	144	39	200	70	5200	8	HV FKA X12	£769.39	HV FKB X12	£957.41
8	200	10	161	287	256	65	204	60	200	71	9300	8	HV FKA X13	£956.82	HV FKB X13	£1,228.62

Suitable for end of line applications

ABS
imperial & metric
MANUAL VALVES

VM DIAPHRAGM VALVES

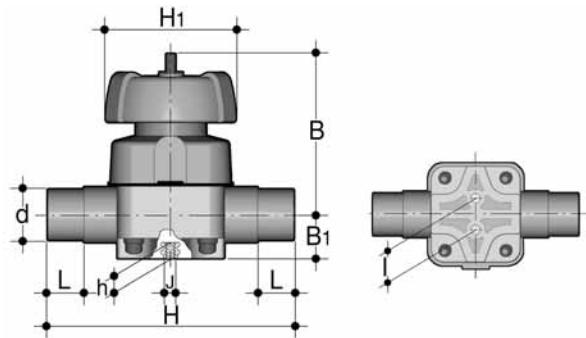

with BS series plain male ends for solvent welding

d	DN	PN	B	B ₁	H	h	H ₁	I	J	L	g	Product Code	List Price (£)	Product Code	List Price (£)	Product Code	List Price (£)
												EPDM		FPM		PTFE	
1/2	15	10	95	26	124	12	90	25	M6	16	700	HO VMA 202	£58.14	HO VMB 202	£77.13	HO VMC 202	£118.94*
3/4	20	10	95	26	144	12	90	25	M6	19	700	HO VMA 203	£69.12	HO VMB 203	£90.79	HO VMC 203	£132.60*
1	25	10	95	26	154	12	90	25	M6	23	700	HO VMA 204	£86.45	HO VMB 204	£108.78	HO VMC 204	£165.59*
1 1/4	32	10	126	40	174	18	115	44.5	M8	27	1500	HO VMA 205	£104.44	HO VMB 205	£133.08	HO VMC 205	£202.90*
1 1/2	40	10	126	40	194	18	115	44.5	M8	32	1500	HO VMA 206	£140.24	HO VMB 206	£174.91	HO VMC 206	£264.85*
2	50	10	148	40	224	18	140	44.5	M8	39	2400	HO VMA 207	£170.73	HO VMB 207	£216.05	HO VMC 207	£325.65*
2 1/2	65	10	225	55	284	23	215	100	M12	44	7000	HO VMA 208	£319.83	HO VMB 208	£391.46	HO VMC 208	£546.39*
3	80	10	225	55	300	23	215	100	M12	51	7000	HO VMA 209	£483.09	HO VMB 209	£571.37	HO VMC 209	£747.94*
4	100	10	295	69	350	23	250	120	M12	-	10500	HO VMA 210	£1,166.05	HO VMB 210	£1,384.27	HO VMC 210	£1,810.71*

Items marked * are manufactured to order. Delivery to be advised.

with Metric series plain male ends for solvent welding

d	DN	PN	B	B ₁	H	h	H ₁	I	J	L	g	Product Code	List Price (£)	Product Code	List Price (£)	Product Code	List Price (£)
												EPDM		FPM		PTFE	
20	15	10	95	26	124	12	90	25	M6	16	700	HO VMA 406	£58.14	HO VMB 406	£77.13	HO VMC 406	£118.94*
25	20	10	95	26	144	12	90	25	M6	19	700	HO VMA 407	£69.12	HO VMB 407	£90.79	HO VMC 407	£132.60*
32	25	10	95	26	154	12	90	25	M6	23	700	HO VMA 408	£86.45	HO VMB 408	£108.78	HO VMC 408	£165.59*
40	32	10	126	40	174	18	115	44.5	M8	27	1500	HO VMA 409	£104.44	HO VMB 409	£133.08	HO VMC 409	£202.90*
50	40	10	126	40	194	18	115	44.5	M8	32	1500	HO VMA 410	£140.24	HO VMB 410	£174.91	HO VMC 410	£264.85*
63	50	10	148	40	224	18	140	44.5	M8	39	2400	HO VMA 411	£170.73	HO VMB 411	£216.05	HO VMC 411	£325.65*
75	65	10	225	55	284	23	215	100	M12	44	7000	HO VMA 412	£319.83	HO VMB 412	£391.46	HO VMC 412	£546.39*
90	80	10	225	55	300	23	215	100	M12	51	7000	HO VMA 413	£483.09	HO VMB 413	£571.37	HO VMC 413	£747.94*
110	100	10	295	69	350	23	250	120	M12	-	10500	HO VMA 414	£1,166.05	HO VMB 414	£1,384.27	HO VMC 414	£1,810.71*

Items marked * are manufactured to order. Delivery to be advised.

VA AIR RELEASE VALVES

with BS series plain female ends for solvent welding

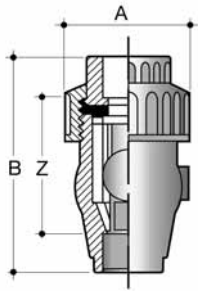

d	Z	A	B	gms	Product Code	List Price (£)
FPM						
3/8	62	48	95	109	HO VAB 101	£69.79
1/2	62	48	95	100	HO VAB 102	£69.79
3/4	73	59	112	165	HO VAB 103	£84.46
1	79	69	124	250	HO VAB 104	£97.27
1 1/4	94	96	148	610	HO VAB 105	£139.93
1 1/2	88	96	148	575	HO VAB 106	£162.58
2	105	103	177	798	HO VAB 107	£200.56

with Metric series plain female ends for solvent welding

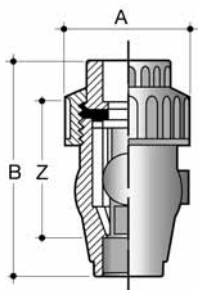

d	Z	A	B	gms	Product Code	List Price (£)
FPM						
16	62	48	95	109	HO VAB 305	£69.79
20	62	48	95	100	HO VAB 306	£69.79
25	73	59	112	165	HO VAB 307	£84.45
32	79	69	124	250	HO VAB 308	£97.28
40	94	96	148	610	HO VAB 309	£139.92
50	88	96	148	575	HO VAB 310	£162.58
63	105	103	177	798	HO VAB 311	£200.56

SR BALL CHECK VALVES

with BS series plain female ends for solvent welding

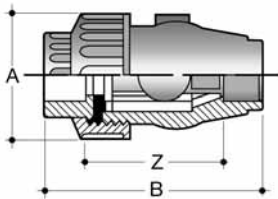

d	Z	A	B	gms	Product Code	List Price (£)	Product Code	List Price (£)
					EPDM		FPM	
3/8	62	48	95	109	HO SRA 101	£49.48	HO SRB 101	£62.63
1/2	62	48	95	100	HO SRA 102	£49.48	HO SRB 102	£62.63
3/4	73	59	112	165	HO SRA 103	£59.80	HO SRB 103	£70.78
1	79	69	124	250	HO SRA 104	£63.14	HO SRB 104	£75.46
1 1/4	94	96	148	610	HO SRA 105	£89.45	HO SRB 105	£116.62
1 1/2	88	96	148	575	HO SRA 106	£101.80	HO SRB 106	£134.93
2	105	103	177	798	HO SRA 107	£139.93	HO SRB 107	£161.58
3	114	178	215	2757	HO SRA 109	£353.15	HO SRB 109	£475.57

with Metric series plain female ends for solvent welding

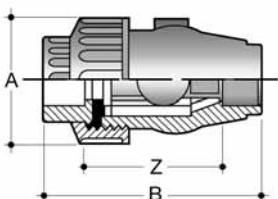

d	Z	A	B	gms	Product Code	List Price (£)	Product Code	List Price (£)
					EPDM		FPM	
16	62	48	95	109	HO SRA 305	£49.48	HO SRB 305	£62.63
20	62	48	95	100	HO SRA 306	£49.48	HO SRB 306	£62.63
25	73	59	112	165	HO SRA 307	£59.80	HO SRB 307	£70.78
32	79	69	124	250	HO SRA 308	£63.14	HO SRB 308	£75.46
40	94	96	148	610	HO SRA 309	£89.45	HO SRB 309	£116.62
50	88	96	148	575	HO SRA 310	£101.80	HO SRB 310	£134.92
63	105	103	177	798	HO SRA 311	£139.93	HO SRB 311	£161.58
90	114	178	215	2757	HO SRA 313	£353.15	HO SRB 313	£475.57

RV SEDIMENT STRAINERS

with BS series plain female ends for solvent welding

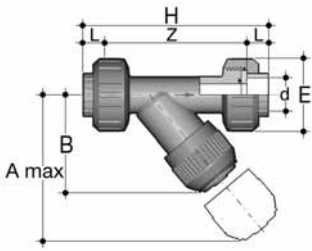

d	DN	PN	A max	B	E	L	Z	H	g	Product Code	List Price (£)	Product Code	List Price (£)
										EPDM		FPM	
3/8	10	16	125	72	55	14	107	135	211	HO UVA 101	£35.15	HO UVB 101	£41.81
1/2	15	16	125	72	55	16	103	135	211	HO UVA 102	£35.15	HO UVB 102	£41.81
3/4	20	16	145	84	66	19	120	158	358	HO UVA 103	£38.98	HO UVB 103	£46.32
1	25	16	165	95	75	22	132	176	526	HO UVA 104	£51.96	HO UVB 104	£59.80
1 1/4	32	16	190	111	87	26	155	207	733	HO UVA 105	£64.30	HO UVB 105	£72.80
1 1/2	40	16	210	120	100	31	181	243	1095	HO UVA 106	£86.14	HO UVB 106	£104.78
2	50	10	240	139	120	38	222	298	1843	HO UVA 107	£108.94	HO UVB 107	£134.93

with Metric series plain female ends for solvent welding

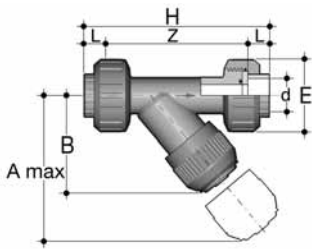

d	DN	PN	A max	B	E	L	Z	H	g	Product Code	List Price (£)	Product Code	List Price (£)
										EPDM		FPM	
16	10	16	125	72	55	14	107	135	211	HO UVA 305	£35.15	HO UVB 305	£41.81
20	15	16	125	72	55	16	103	135	211	HO UVA 306	£35.15	HO UVB 306	£41.81
25	20	16	145	84	66	19	120	158	358	HO UVA 307	£38.98	HO UVB 307	£46.32
32	25	16	165	95	75	22	132	176	526	HO UVA 308	£51.96	HO UVB 308	£59.80
40	32	16	190	111	87	26	155	207	733	HO UVA 309	£64.30	HO UVB 309	£72.80
50	40	16	210	120	100	31	181	243	1095	HO UVA 310	£86.14	HO UVB 310	£104.78
63	50	10	240	139	120	38	222	298	1843	HO UVA 311	£108.94	HO UVB 311	£134.92

with BS parallel threaded female ends

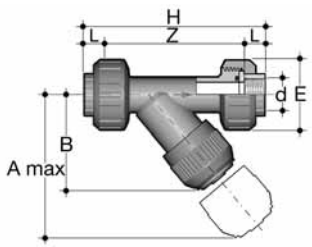

d	DN	PN	A max	B	E	L	Z	H	g	Product Code	List Price (£)	Product Code	List Price (£)
										EPDM		FPM	
1/2	15	16	125	72	55	16	103	135	211	HO UVA B02	£42.63	HO UVB B02	£48.20
3/4	20	16	145	84	66	19	120	158	358	HO UVA B03	£47.84	HO UVB B03	£55.19
1	25	16	165	95	75	22	132	176	526	HO UVA B04	£63.96	HO UVB B04	£71.79
1 1/4	32	16	190	111	87	26	155	207	733	HO UVA B05	£83.11	HO UVB B05	£88.35
1 1/2	40	16	210	120	100	31	181	243	1095	HO UVA B06	£107.60	HO UVB B06	£126.26
2	50	10	240	139	120	38	222	298	1843	HO UVA B07	£138.49	HO UVB B07	£164.47

PR PRESSURE RELIEF VALVES

with BS series male ends for solvent welding

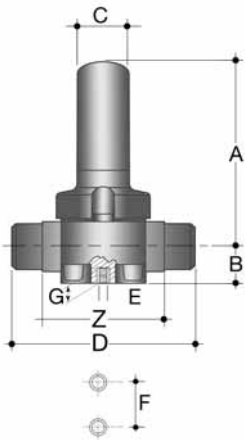

d	Z	A	B	C	D	E	F	G	kg	Product Code	List Price (£)	Product Code	List Price (£)
										EPDM		FPM	
1/2	92	143	20.5	35	124	M6	25	12	0.7	HO PRA 202	£298.18	HO PRB 202	£343.15
3/4	106	143	20.5	35	144	M6	25	12	0.7	HO PRA 203	£321.50	HO PRB 203	£370.64
1	108	143	25	35	154	M6	25	12	0.7	HO PRA 204	£348.15	HO PRB 204	£400.61
1 1/4	120	204	36	50	174	M8	44.5	16	1.5	HO PRA 205	£408.12	HO PRB 205	£470.59
1 1/2	130	204	39.5	50	194	M8	44.5	16	1.5	HO PRA 206	£473.91	HO PRB 206	£545.55
2	146	219	49	50	224	M8	44.5	16	2.4	HO PRA 207	£541.39	HO PRB 207	£624.67

with Metric series male ends for solvent welding

d	Z	A	B	C	D	E	F	G	kg	Product Code	List Price (£)	Product Code	List Price (£)
										EPDM		FPM	
20	92	143	20.5	35	124	M6	25	12	0.7	HO PRA 406	£297.34	HO PRB 406	£327.06
25	106	143	20.5	35	144	M6	25	12	0.7	HO PRA 407	£321.50	HO PRB 407	£353.65
32	108	143	25	35	154	M6	25	12	0.7	HO PRA 408	£348.16	HO PRB 408	£382.96
40	120	204	36	50	174	M8	44.5	16	1.5	HO PRA 409	£408.45	HO PRB 409	£449.30
50	130	204	39.5	50	194	M8	44.5	16	1.5	HO PRA 410	£474.08	HO PRB 410	£521.50
63	146	219	49	50	224	M8	44.5	16	2.4	HO PRA 411	£542.21	HO PRB 411	£596.42

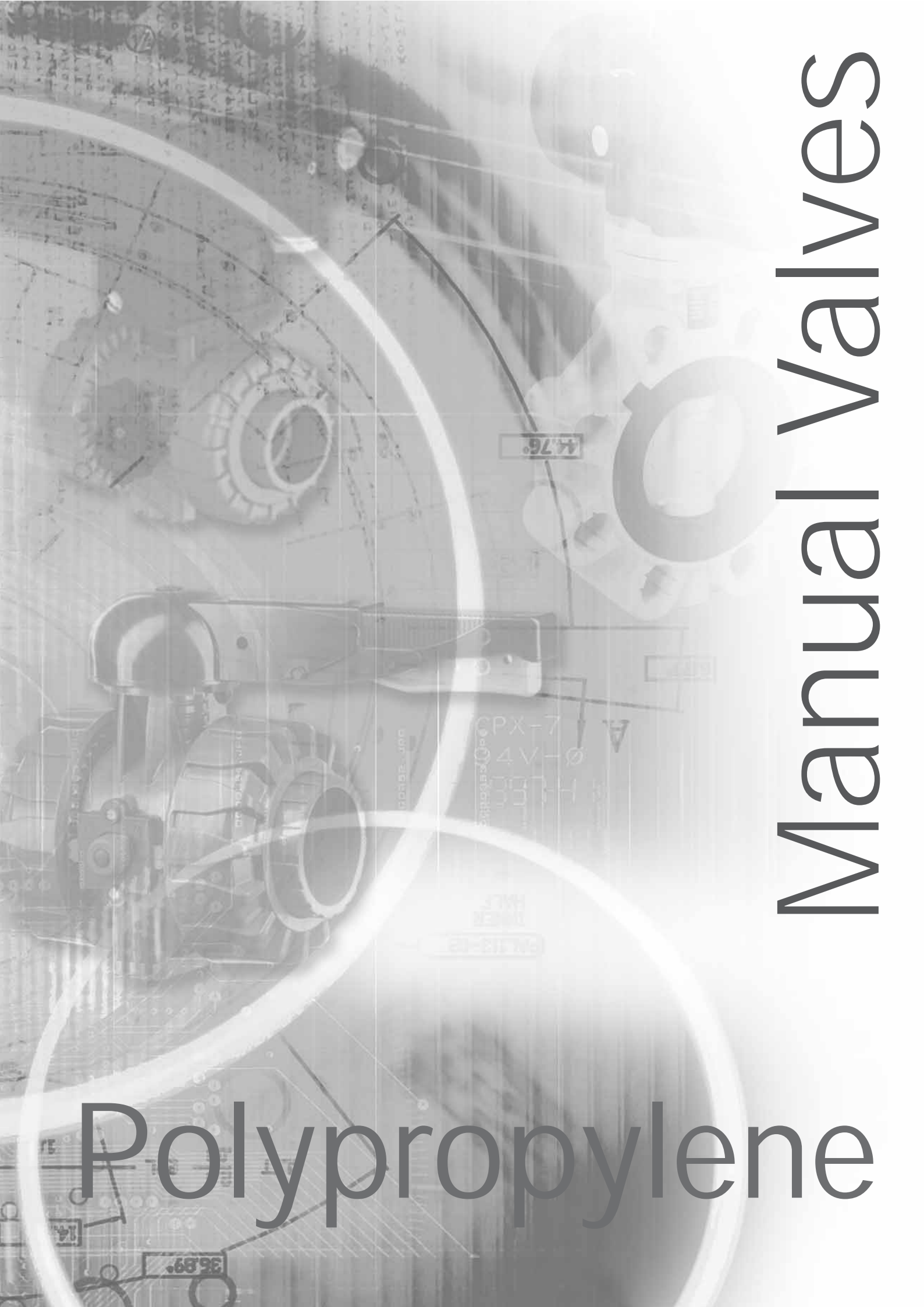

Manual Valves

Polyppropylene

VKD DOUBLE UNION BALL VALVES (1/2"/d20 to 2"/d63)

with BS series plain female ends - Standard valve

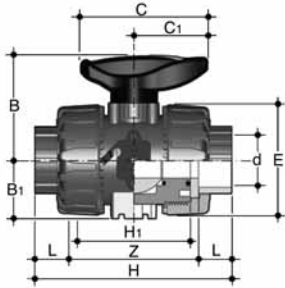

d	DN	PN	L	Z	H	H ₁	E	B	B ₁	C	C ₁	g	Product Code	List Price (£)	Product Code	List Price (£)
													EPDM		FPM	
1/2	15	10	14.5	73	102	65	54	54	29	67	40	145	HO DKN 102	£41.38	HO DKP 102	£50.36
3/4	20	10	16	82	114	70	65	65	34.5	85	49	218	HO DKN 103	£49.08	HO DKP 103	£58.70
1	25	10	18	90	126	78	73	69.5	39	85	49	298	HO DKN 104	£60.30	HO DKP 104	£73.13
1 1/4	32	10	20.5	100	141	88	86	82.5	46	108	64	480	HO DKN 105	£75.70	HO DKP 105	£91.74
1 1/2	40	10	23.5	117	164	93	98	89	52	108	64	682	HO DKN 106	£97.51	HO DKP 106	£120.61
2	50	10	27.5	144	199	111	122	108	62	134	76	1166	HO DKN 107	£120.61	HO DKP 107	£153.96

with BS series plain female ends - Valve, with lockable handle

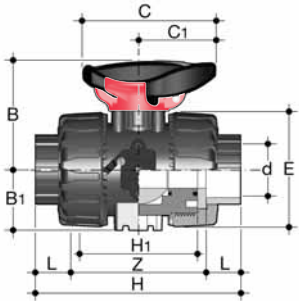

d	DN	PN	L	Z	H	H ₁	E	B	B ₁	C	C ₁	g	Product Code	List Price (£)	Product Code	List Price (£)
													EPDM		FPM	
1/2	15	10	14.5	73	102	65	54	54	29	67	40	145	HO DLN 102	£54.79	HO DLP 102	£63.77
3/4	20	10	16	82	114	70	65	65	34.5	85	49	218	HO DLN 103	£64.07	HO DLP 103	£73.69
1	25	10	18	90	126	78	73	69.5	39	85	49	298	HO DLN 104	£75.29	HO DLP 104	£88.12
1 1/4	32	10	20.5	100	141	88	86	82.5	46	108	64	480	HO DLN 105	£93.05	HO DLP 105	£109.09
1 1/2	40	10	23.5	117	164	93	98	89	52	108	64	682	HO DLN 106	£114.87	HO DLP 106	£137.96
2	50	10	27.5	144	199	111	122	108	62	134	76	1166	HO DLN 107	£139.22	HO DLP 107	£172.58

with Metric series plain female ends - Standard valve

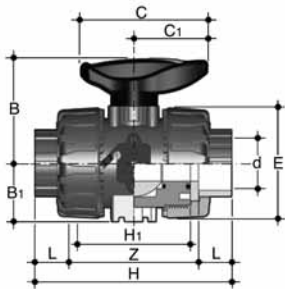

d	DN	PN	L	Z	H	H ₁	E	B	B ₁	C	C ₁	g	Product Code	List Price (£)	Product Code	List Price (£)
													EPDM		FPM	
20	15	10	16	71	103	65	54	54	29	67	40	145	HO DKN 306	£41.38	HO DKP 306	£50.37
25	20	10	19	77	115	70	65	65	34.5	85	49	218	HO DKN 307	£49.08	HO DKP 307	£58.70
32	25	10	22	84	128	78	73	69.5	39	85	49	298	HO DKN 308	£60.30	HO DKP 308	£73.13
40	32	10	26	94	146	88	86	82.5	46	108	64	480	HO DKN 309	£75.70	HO DKP 309	£91.74
50	40	10	31	102	164	93	98	89	52	108	64	682	HO DKN 310	£97.51	HO DKP 310	£120.61
63	50	10	38	123	199	111	122	108	62	134	76	1166	HO DKN 311	£120.61	HO DKP 311	£153.96

with Metric series plain female ends - Valve, with lockable handle

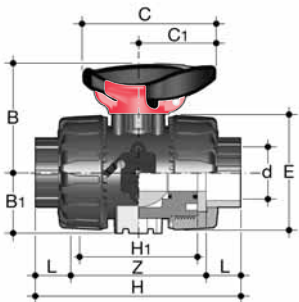

d	DN	PN	L	Z	H	H ₁	E	B	B ₁	C	C ₁	g	Product Code	List Price (£)	Product Code	List Price (£)
													EPDM		FPM	
20	15	10	16	71	103	65	54	54	29	67	40	145	HO DLN 306	£54.79	HO DLP 306	£63.78
25	20	10	19	77	115	70	65	65	34.5	85	49	218	HO DLN 307	£64.07	HO DLP 307	£73.69
32	25	10	22	84	128	78	73	69.5	39	85	49	298	HO DLN 308	£75.29	HO DLP 308	£88.12
40	32	10	26	94	146	88	86	82.5	46	108	64	480	HO DLN 309	£93.05	HO DLP 309	£109.09
50	40	10	31	102	164	93	98	89	52	108	64	682	HO DLN 310	£114.87	HO DLP 310	£137.96
63	50	10	38	123	199	111	122	108	62	134	76	1166	HO DLN 311	£139.23	HO DLP 311	£172.58

VKD DOUBLE UNION BALL VALVES (1/2"/d20 to 2"/d63)

with BS parallel threaded female ends - Standard valve

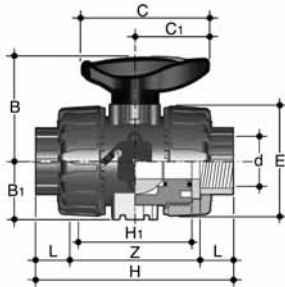

d	DN	PN	L	Z	H	H ₁	E	B	B ₁	C	C ₁	g	Product Code	List Price (£)	Product Code	List Price (£)
													EPDM		FPM	
1/2	15	10	16.5	70	103	65	54	54	29	67	40	145	HO DKN B02	£48.06	HO DKP B02	£58.45
3/4	20	10	19	77	115	70	65	65	34.5	85	49	220	HO DKN B03	£54.73	HO DKP B03	£65.44
1	25	10	22.5	83	128	78	73	69.5	39	85	49	298	HO DKN B04	£66.72	HO DKP B04	£81.47
1 1/4	32	10	26	94	146	88	86	82.5	46	108	64	488	HO DKN B05	£83.40	HO DKP B05	£102.64
1 1/2	40	10	30	104	164	93	98	89	52	108	64	682	HO DKN B06	£107.13	HO DKP B06	£125.10
2	50	10	36	127	199	111	122	108	62	134	76	1181	HO DKN B07	£136.00	HO DKP B07	£169.36

with BS parallel threaded female ends - Valve, with lockable handle

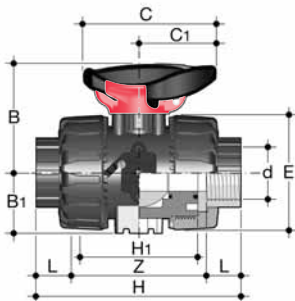

d	DN	PN	L	Z	H	H ₁	E	B	B ₁	C	C ₁	g	Product Code	List Price (£)	Product Code	List Price (£)
													EPDM		FPM	
1/2	15	10	16.5	70	103	65	54	54	29	67	40	145	HO DLN B02	£61.47	HO DLP B02	£71.86
3/4	20	10	19	77	115	70	65	65	34.5	85	49	220	HO DLN B03	£69.72	HO DLP B03	£80.43
1	25	10	22.5	83	128	78	73	69.5	39	85	49	298	HO DLN B04	£81.71	HO DLP B04	£96.46
1 1/4	32	10	26	94	146	88	86	82.5	46	108	64	488	HO DLN B05	£100.75	HO DLP B05	£120.00
1 1/2	40	10	30	104	164	93	98	89	52	108	64	682	HO DLN B06	£124.49	HO DLP B06	£142.45
2	50	10	36	127	199	111	122	108	62	134	76	1181	HO DLN B07	£154.62	HO DLP B07	£187.98

with Flanged ends BS4504 PN10 - Standard valve

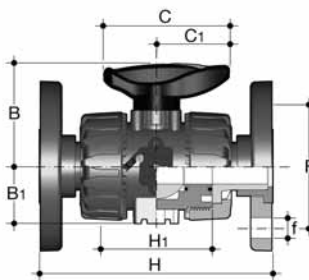

d	DN	PN	H	H ₁	B	B ₁	C	C ₁	F	f	U	g	Product Code	List Price (£)	Product Code	List Price (£)
													EPDM		FPM	
1/2	15	10	-	65	54	29	67	40	60.3	15.9	4	460	HO DKN F02	£73.53	HO DKP F02	£82.51
3/4	20	10	-	70	65	34.5	85	49	69.9	15.9	4	632	HO DKN F03	£84.39	HO DKP F03	£94.01
1	25	10	-	78	69.5	39	85	49	79.4	15.9	4	853	HO DKN F04	£101.17	HO DKP F04	£114.00
1 1/4	32	10	-	88	82.5	46	108	64	88.9	15.9	4	1313	HO DKN F05	£113.99	HO DKP F05	£130.02
1 1/2	40	10	-	93	89	52	108	64	98.4	15.9	4	1669	HO DKN F06	£146.83	HO DKP F06	£169.93
2	50	10	-	111	108	62	134	76	120.7	19.1	4	2577	HO DKN F07	£179.47	HO DKP F07	£212.83

with Flanged ends BS4504 PN10 - Valve, with lockable handle

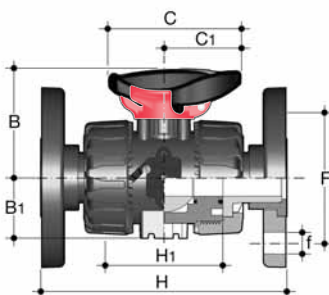

d	DN	PN	H	H ₁	B	B ₁	C	C ₁	F	f	U	g	Product Code	List Price (£)	Product Code	List Price (£)
													EPDM		FPM	
1/2	15	10	-	65	54	29	67	40	60.3	15.9	4	387	HO DLN F02	£86.94	HO DLP F02	£95.92
3/4	20	10	-	70	65	34.5	85	49	69.9	15.9	4	504	HO DLN F03	£99.38	HO DLP F03	£109.00
1	25	10	-	78	69.5	39	85	49	79.4	15.9	4	697	HO DLN F04	£116.16	HO DLP F04	£128.99
1 1/4	32	10	-	88	82.5	46	108	64	88.9	15.9	4	1075	HO DLN F05	£131.34	HO DLP F05	£147.37
1 1/2	40	10	-	93	89	52	108	64	98.4	15.9	4	1346	HO DLN F06	£164.18	HO DLP F06	£187.28
2	50	10	-	111	108	62	134	76	120.7	19.1	4	2060	HO DLN F07	£198.09	HO DLP F07	£231.45

POLYPROPYLENE
imperial & metric
MANUAL VALVES

VKD 2-WAY BALL VALVES

with Metric series plain female - socket fusion

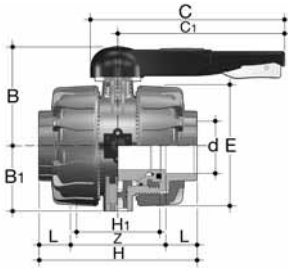

d	DN	PN	Z	L	H	H ₁	E	B	B ₁	C	C ₁	g	Product Code	List Price (£)	Product Code	List Price (£)
													EPDM		FPM	
75	65	10	147	44	235	133	164	164	87	225	175	3090	HO DKN 312	£233.28	HO DKP 312	£282.27
90	80	10	168	51	270	149	203	177	105	327	272	5080	HO DKN 313	£408.24	HO DKP 313	£493.97
110	100	10	186	61	308	167	238	195	129	385	330	7725	HO DKN 314	£513.22	HO DKP 314	£620.99

BS4504 PN10/ANSI 150 flanged ends

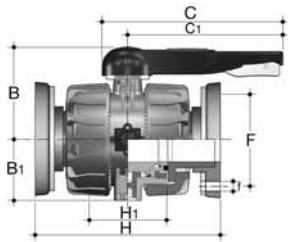

d	DN	PN	H	H ₁	B	B ₁	C	C ₁	f	F	g	Product Code	List Price (£)	Product Code	List Price (£)
												EPDM		FPM	
75	65	10	290	133	164	87	225	175	17	145	4500	HO DKN X08	£443.23	HO DKP X08	£492.22
90	80	10	310	149	177	105	327	272	17	160	6455	HO DKN X09	£647.35	HO DKP X09	£733.08
110	100	10	350	167	195	129	385	330	17	180	9090	HO DKN X10	£775.66	HO DKP X10	£883.43

TKD 3-WAY BALL VALVES



with BS series plain female ends for socket fusion (T Port)

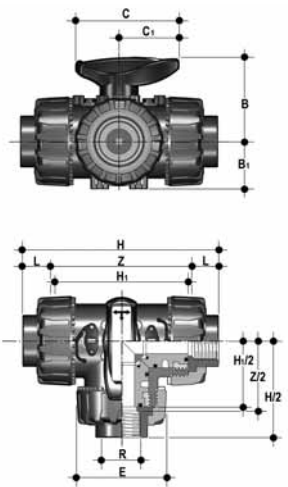

d	DN	PN	H	Z	C	C ₁	B	B ₁	g	Product Code	List Price (£)	Product Code	List Price (£)
										EPDM		FPM	
1/2	15	16	125	95	67	40	54	29	310	HO TTN 102	£83.02	HO TTP 102	£85.59
3/4	20	16	146	114	85	49	65	34.5	550	HO TTN 103	£97.41	HO TTP 103	£100.43
1	25	16	166	129	85	49	65.9	39	790	HO TTN 104	£118.07	HO TTP 104	£121.73
1 1/4	32	16	195.5	151	108	64	82.5	46	1275	HO TTN 105	£130.37	HO TTP 105	£134.40
1 1/2	40	16	211	166	108	64	89	52	1660	HO TTN 106	£226.33	HO TTP 106	£233.33
2	50	16	253.5	199	134	76	108	62	2800	HO TTN 107	£283.45	HO TTP 107	£292.22

with Metric series plain female ends for socket fusion (T Port)

d	DN	PN	H	Z	C	C ₁	B	B ₁	g	Product Code	List Price (£)	Product Code	List Price (£)
										EPDM		FPM	
20	15	16	118	86	67	40	54	29	310	HO TTN 306	£83.02	HO TTP 306	£85.59
25	20	16	145	107	85	49	65	34.5	550	HO TTN 307	£97.41	HO TTP 307	£100.43
32	25	16	160	116	85	49	65.9	39	790	HO TTN 308	£118.07	HO TTP 308	£121.73
40	32	16	188.5	136.5	108	64	82.5	46	1275	HO TTN 309	£130.37	HO TTP 309	£134.40
50	40	16	219	157	108	64	89	52	1660	HO TTN 310	£226.33	HO TTP 310	£233.33
63	50	16	266.5	190.5	134	76	108	62	2800	HO TTN 311	£283.45	HO TTP 311	£292.22

with BS parallel threaded female ends (T Port)

d	DN	PN	H	Z	C	C ₁	B	B ₁	g	Product Code	List Price (£)	Product Code	List Price (£)
										EPDM		FPM	
1/2	15	16	125	95	67	40	54	29	310	HO TTN B02	£83.54	HO TTP B02	£88.82
3/4	20	16	146	114	85	49	65	34.5	550	HO TTN B03	£112.22	HO TTP B03	£104.07
1	25	16	166	129	85	49	65.9	39	790	HO TTN B04	£132.89	HO TTP B04	£129.87
1 1/4	32	16	195.5	151	108	64	82.5	46	1275	HO TTN B05	£166.35	HO TTP B05	£158.11
1 1/2	40	16	211	166	108	64	89	52	1660	HO TTN B06	£275.88	HO TTP B06	£259.00
2	50	16	253.5	199	134	76	108	62	2800	HO TTN B07	£361.88	HO TTP B07	£339.03

See page 79 for a full list of TKD accessories.

TKD 3-WAY BALL VALVES



with BS series plain female ends for socket fusion (L Port)

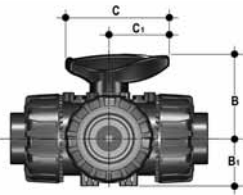

d	DN	PN	H	Z	C	C ₁	B	B ₁	g	Product Code	List Price (£)	Product Code	List Price (£)
										EPDM		FPM	
1/2	15	16	125	95	67	40	54	29	310	HO LTN 102	£83.02	HO LTP 102	£85.59
3/4	20	16	146	114	85	49	65	34.5	550	HO LTN 103	£97.41	HO LTP 103	£100.43
1	25	16	166	129	85	49	65.9	39	790	HO LTN 104	£118.07	HO LTP 104	£121.73
1 1/4	32	16	195.5	151	108	64	82.5	46	1275	HO LTN 105	£130.37	HO LTP 105	£134.40
1 1/2	40	16	211	166	108	64	89	52	1660	HO LTN 106	£226.33	HO LTP 106	£233.33
2	50	16	253.5	199	134	76	108	62	2800	HO LTN 107	£283.45	HO LTP 107	£292.22

with Metric series plain female ends for socket fusion (L Port)

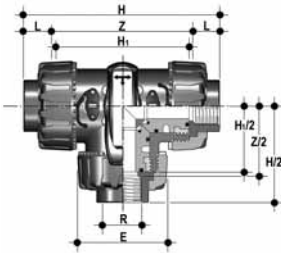

d	DN	PN	H	Z	C	C ₁	B	B ₁	g	Product Code	List Price (£)	Product Code	List Price (£)
										EPDM		FPM	
20	15	16	118	86	67	40	54	29	310	HO LTN 306	£83.02	HO LTP 306	£85.59
25	20	16	145	107	85	49	65	34.5	550	HO LTN 307	£97.41	HO LTP 307	£100.43
32	25	16	160	116	85	49	65.9	39	790	HO LTN 308	£118.07	HO LTP 308	£121.73
40	32	16	188.5	136.5	108	64	82.5	46	1275	HO LTN 309	£130.37	HO LTP 309	£134.40
50	40	16	219	157	108	64	89	52	1660	HO LTN 310	£226.33	HO LTP 310	£233.33
63	50	16	266.5	190.5	134	76	108	62	2800	HO LTN 311	£283.45	HO LTP 311	£292.22

with BS parallel threaded female ends (L Port)

d	DN	PN	H	Z	C	C ₁	B	B ₁	g	Product Code	List Price (£)	Product Code	List Price (£)
										EPDM		FPM	
1 1/2	15	16	125	95	67	40	54	29	310	HO LTN B02	£83.54	HO LTP B02	£88.82
3/4	20	16	146	114	85	49	65	34.5	550	HO LTN B03	£112.22	HO LTP B03	£104.07
1	25	16	166	129	85	49	65.9	39	790	HO LTN B04	£132.89	HO LTP B04	£129.87
1 1/4	32	16	195.5	151	108	64	82.5	46	1275	HO LTN B05	£166.35	HO LTP B05	£158.11
1 1/2	40	16	211	166	108	64	89	52	1660	HO LTN B06	£275.88	HO LTP B06	£259.00
2	50	16	253.5	199	134	76	108	62	2800	HO LTN B07	£361.88	HO LTP B07	£339.03

See page 79 for a full list of TKD accessories.

BALL VALVE ACCESSORIES

End connectors in PE- VKD, VX, VE, VT, SK, long spigot, for electrofusion or butt weld

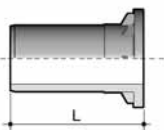

d	DN	L	H	Product Code	List Price (£)
20	15	55	175	HZ PEE M06	£4.86
25	20	70	210	HZ PEE M07	£4.97
32	25	74	224	HZ PEE M08	£5.08
40	32	78	243	HZ PEE M09	£7.89
50	40	84	261	HZ PEE M10	£9.39
63	50	91	293	HZ PEE M11	£13.30
75	65	111	356	HZ PEE M12	POA
90	80	118	390	HZ PEE M13	POA
110	100	132	432	HZ PEE M14	POA

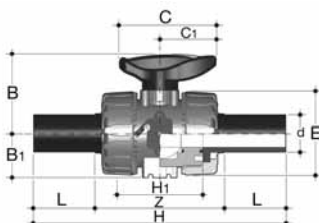

End connectors in PP- VKD, VX, VE, VT, SK, long spigot, for electrofusion or butt weld

d	DN	L	H	Product Code	List Price (£)
20	15	55	175	HZ PPE M06	£4.15
25	20	70	210	HZ PPE M07	£4.88
32	25	74	224	HZ PPE M08	£5.98
40	32	78	243	HZ PPE M09	£7.45
50	40	84	261	HZ PPE M10	£9.67
63	50	91	293	HZ PPE M11	£12.46
75	65	111	356	HZ PPE M12	£25.16
90	80	118	390	HZ PPE M13	£31.64
110	100	132	432	HZ PPE M14	£38.34

FK BUTTERFLY VALVES - GRPP BODY WITH POLYPROPYLENE DISC

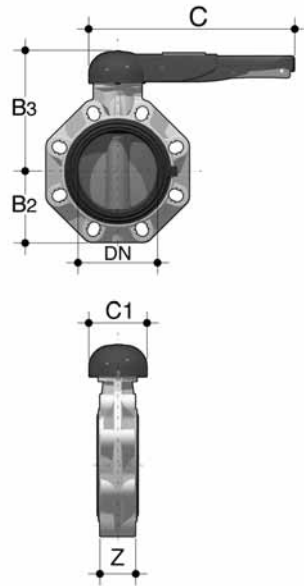

Lever operated - PN10/ANSI/BS10

d	DN	PN	B ₂	B ₃	C	C ₁	Z	g	U	Product Code	List Price (£)	Product Code	List Price (£)
										EPDM	FPM	EPDM	FPM
1½	40	16	60	137	175	100	33	900	4	H0 FKN 106	£114.48	H0 FKP 106	£138.44
2	50	16	70	143	175	100	43	1080	4	H0 FKN 107	£120.76	H0 FKP 107	£146.69
2½	65	10	80	164	272	110	46	1470	4	H0 FKN 108	£132.62	H0 FKP 108	£162.90
3	80	10	93	178	272	110	49	1870	8	H0 FKN 109	£146.16	H0 FKP 109	£170.82
4	100	10	107	192	272	110	56	2220	8	H0 FKN 110	£177.02	H0 FKP 110	£203.98
5	125	10	120	212	330	110	64	3100	8	H0 FKN 111	£229.20	H0 FKP 111	£256.58
6	150	10	134	225	330	110	70	3850	8	H0 FKN 112	£281.83	H0 FKP 112	£314.97
8	200	10	161	272	420	122	71	6750	8	H0 FKN 113	£419.47	H0 FKP 113	£459.84

Lever operated - LUGGED BS 4504, PN10

d	DN	PN	B ₂	B ₃	C	C ₁	Z	g	U	Product Code	List Price (£)	Product Code	List Price (£)
										EPDM	FPM	EPDM	FPM
2½	65	10	80	164	272	110	46	1470	4	H0 FKN F08	£206.50	H0 FKP F08	£279.54
3	80	10	93	178	272	110	49	1870	8	H0 FKN F09	£239.74	H0 FKP F09	£322.19
4	100	10	107	192	272	110	56	2220	8	H0 FKN F10	£295.09	H0 FKP F10	£406.78
5	125	10	120	212	330	110	64	3100	8	H0 FKN F11	£374.99	H0 FKP F11	£518.35
6	150	10	134	225	330	110	70	3850	8	H0 FKN F12	£455.66	H0 FKP F12	£629.77
8	200	10	161	272	420	122	71	6750	8	H0 FKN F13	£566.00	H0 FKP F13	£817.81

Suitable for end of line applications

Lever operated - LUGGED ANSI 150

d	DN	PN	B ₂	B ₃	C	C ₁	Z	g	U	Product Code	List Price (£)	Product Code	List Price (£)
										EPDM	FPM	EPDM	FPM
2½	65	10	80	164	272	110	46	1470	4	H0 FKN X08	£236.05	H0 FKP X08	£309.08
3	80	10	93	178	272	110	49	1870	8	H0 FKN X09	£271.69	H0 FKP X09	£354.13
4	100	10	107	192	272	110	56	2220	8	H0 FKN X10	£334.62	H0 FKP X10	£446.30
5	125	10	120	212	330	110	64	3100	8	H0 FKN X11	£424.98	H0 FKP X11	£568.33
6	150	10	134	225	330	110	70	3850	8	H0 FKN X12	£516.69	H0 FKP X12	£690.78
8	200	10	161	272	420	122	71	6750	8	H0 FKN X13	£646.52	H0 FKP X13	£898.33

Suitable for end of line applications

FK BUTTERFLY VALVES - GRPP BODY WITH POLYPROPYLENE DISC

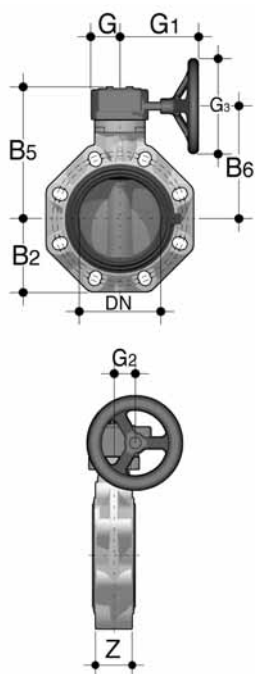

Gear box operated - PN10/ANSI/BS10

d	DN	PN	B2	B5	B6	G	G1	G2	G3	Z	g	U	Product Code	List Price (£)	Product Code	List Price (£)
													EPDM		FPM	
2 1/2	65	10	80	174	146	48	135	39	125	46	2400	4	HV FKN 108	£328.33	HV FKP 108	£358.56
3	80	10	93	188	160	48	135	39	125	49	2800	8	HV FKN 109	£341.88	HV FKP 109	£366.54
4	100	10	107	202	174	48	135	39	125	56	3150	8	HV FKN 110	£372.73	HV FKP 110	£399.69
5	125	10	120	222	194	48	144	39	200	64	4450	8	HV FKN 111	£424.91	HV FKP 111	£452.30
6	150	10	134	235	207	48	144	39	200	70	5200	8	HV FKN 112	£477.53	HV FKP 112	£510.69
8	200	10	161	287	256	65	204	60	200	71	9300	8	HV FKN 113	£658.90	HV FKP 113	£699.26
10	250	10	210	317	281	88	236	76	250	114	18600	12	HV FKN 114	£1,142.25	HV FKP 114	£1,950.49
12	300	8	245	374	338	88	236	76	250	114	25600	12	HV FKN 115	£1,232.18	HV FKP 115	£2,111.78

Gear box operated - LUGGED BS 4504, PN10

d	DN	PN	B2	B5	B6	G	G1	G2	G3	Z	g	U	Product Code	List Price (£)	Product Code	List Price (£)
													EPDM		FPM	
2 1/2	65	10	80	174	146	48	135	39	125	46	2400	4	HV FKN F08	£402.22	HV FKP F08	£475.25
3	80	10	93	188	160	48	135	39	125	49	2800	8	HV FKN F09	£435.46	HV FKP F09	£517.91
4	100	10	107	202	174	48	135	39	125	56	3150	8	HV FKN F10	£490.81	HV FKP F10	£602.49
5	125	10	120	222	194	48	144	39	200	64	4450	8	HV FKN F11	£570.71	HV FKP F11	£714.06
6	150	10	134	235	207	48	144	39	200	70	5200	8	HV FKN F12	£651.38	HV FKP F12	£825.48
8	200	10	161	287	256	65	204	60	200	71	9300	8	HV FKN F13	£805.43	HV FKP F13	£1,057.10

Suitable for end of line applications

Gear box operated - LUGGED ANSI 150

d	DN	PN	B2	B5	B6	G	G1	G2	G3	Z	g	U	Product Code	List Price (£)	Product Code	List Price (£)
													EPDM		FPM	
2 1/2	65	10	80	174	146	48	135	39	125	46	2400	4	HV FKN X08	£431.76	HV FKP X08	£504.80
3	80	10	93	188	160	48	135	39	125	49	2800	8	HV FKN X09	£467.40	HV FKP X09	£549.84
4	100	10	107	202	174	48	135	39	125	56	3150	8	HV FKN X10	£530.33	HV FKP X10	£642.01
5	125	10	120	222	194	48	144	39	200	64	4450	8	HV FKN X11	£620.69	HV FKP X11	£764.05
6	150	10	134	235	207	48	144	39	200	70	5200	8	HV FKN X12	£712.40	HV FKP X12	£886.49
8	200	10	161	287	256	65	204	60	200	71	9300	8	HV FKN X13	£885.94	HV FKP X13	£1,137.61

Suitable for end of line applications

VM DIAPHRAGM VALVES

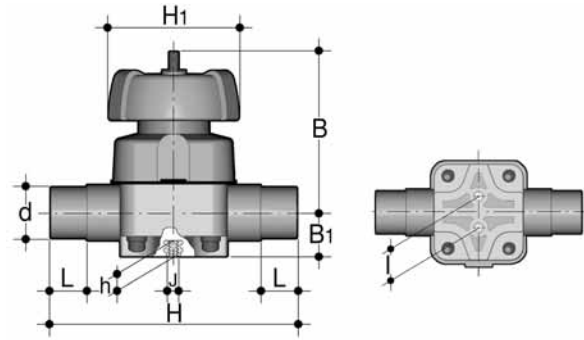

with BS series male ends for socket fusion

d	DN	PN	B	B ₁	H	h	H ₁	I	J	L	g	Product Code	List Price (£)	Product Code	List Price (£)	Product Code	List Price (£)
												EPDM		FPM		PTFE	
1/2	15	10	95	26	124	12	90	25	M6	16	600	HO VMN 202	£47.50	HO VMP 202	£58.48	HO VMQ 202	£81.94
3/4	20	10	95	26	144	12	90	25	M6	19	600	HO VMN 203	£53.13	HO VMP 203	£65.63	HO VMQ 203	£88.55
1	25	10	95	26	154	12	90	25	M6	23	1200	HO VMN 204	£66.31	HO VMP 204	£82.37	HO VMQ 204	£97.88
1 1/2	40	10	126	40	194	18	115	44.5	M8	32	1200	HO VMN 206	£103.51	HO VMP 206	£134.81	HO VMQ 206	£149.09
2	50	10	148	40	224	18	140	44.5	M8	39	1900	HO VMN 207	£129.87	HO VMP 207	£167.08	HO VMQ 207	£186.85
2 1/2	65	10	225	55	284	23	215	100	M12	44	6000	HO VMN 208	£240.94	HO VMP 208	£451.67	HO VMQ 208	£344.59
3	80	10	225	55	300	23	215	100	M12	51	6000	HO VMN 209	£301.34	HO VMP 209	£512.07	HO VMQ 209	£401.57

with Metric series male ends for socket fusion

d	DN	PN	B	B ₁	H	h	H ₁	I	J	L	g	Product Code	List Price (£)	Product Code	List Price (£)	Product Code	List Price (£)
												EPDM		FPM		PTFE	
20	15	10	95	26	124	12	90	25	M6	16	600	HO VMN 406	£51.69	HO VMP 406	£58.48	HO VMQ 406	£106.40
25	20	10	95	26	144	12	90	25	M6	19	600	HO VMN 407	£57.46	HO VMP 407	£65.76	HO VMQ 407	£111.20
32	25	10	95	26	154	12	90	25	M6	23	600	HO VMN 408	£72.00	HO VMP 408	£82.23	HO VMQ 408	£133.17
40	32	10	126	40	174	18	115	44.5	M8	27	1200	HO VMN 409	£88.55	HO VMP 409	£102.00	HO VMQ 409	£170.24
50	40	10	126	40	194	18	115	44.5	M8	32	1200	HO VMN 410	£116.70	HO VMP 410	£134.81	HO VMQ 410	£210.05
63	50	10	148	40	224	18	140	44.5	M8	39	1900	HO VMN 411	£146.90	HO VMP 411	£167.08	HO VMQ 411	£262.22
75	65	10	225	55	284	23	215	100	M12	44	6000	HO VMN 412	£260.84	HO VMP 412	£451.67	HO VMQ 412	£442.05
90	80	10	225	55	300	23	215	100	M12	51	6000	HO VMN 413	£326.74	HO VMP 413	£512.07	HO VMQ 413	£442.06
110	100	10	295	69	350	23	250	120	M12	-	9000	HO VMN 414	£510.13	HO VMP 414	£750.85	HO VMQ 414	£775.37

with unionised Metric series male ends for socket fusion

d	DN	PN	B	B ₁	H	h	H ₁	I	J	L	g	Product Code	List Price (£)	Product Code	List Price (£)	Product Code	List Price (£)
												EPDM		FPM		PTFE	
20	15	10	95	26	147	12	90	25	M6	16	710	HO UMN 306	£91.71	HO UMP 306	£134.84	HO UMQ 306	£153.14
25	20	10	95	26	154	12	90	25	M6	19	750	HO UMN 307	£98.19	HO UMP 307	£143.46	HO UMQ 307	£160.68
32	25	10	95	26	168	12	90	25	M6	23	780	HO UMN 308	£114.34	HO UMP 308	£158.55	HO UMQ 308	£175.78
40	32	10	126	40	192	16	115	44.5	M8	27	1420	HO UMN 309	£132.71	HO UMP 309	£206.04	HO UMQ 309	£226.55
50	40	10	126	40	222	16	115	44.5	M8	32	1460	HO UMN 310	£168.23	HO UMP 310	£241.64	HO UMQ 310	£262.06
63	50	10	148	40	266	16	140	44.5	M8	39	2380	HO UMN 311	£208.18	HO UMP 311	£332.19	HO UMQ 311	£368.10

VM DIAPHRAGM VALVES

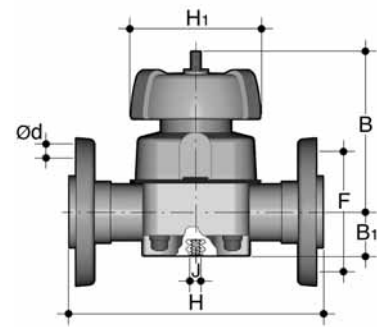

with Flanges to BS 4504 PN10

d	DN	PN	B	B ₁	H	U	H ₁	F	J	Ød	g	Product Code	List Price (£)	Product Code	List Price (£)	Product Code	List Price (£)
												EPDM		FPM		PTFE	
1/2	15	10	95	26	130	4	90	65	M6	14	740	HO VMN F02	£81.51	HO VMP F02	£88.30	HO VMQ F02	£139.92
3/4	20	10	95	26	150	4	90	75	M6	14	800	HO VMN F03	£90.98	HO VMP F03	£99.28	HO VMQ F03	£148.24
1	25	10	95	26	160	4	90	85	M6	14	890	HO VMN F04	£109.05	HO VMP F04	£119.27	HO VMQ F04	£165.87
1 1/4	32	10	126	40	180	4	115	100	M8	18	1660	HO VMN F05	£121.25	HO VMP F05	£134.70	HO VMQ F05	£212.22
1 1/2	40	10	126	40	200	4	115	110	M8	18	1775	HO VMN F06	£158.67	HO VMP F06	£176.80	HO VMQ F06	£259.52
2	50	10	148	40	230	4	140	125	M8	18	2670	HO VMN F07	£196.37	HO VMP F07	£216.55	HO VMQ F07	£321.87
2 1/2	65	10	225	55	290	4	215	145	M12	18	7100	HO VMN F08	£320.49	HO VMP F08	£511.32	HO VMQ F08	£449.75
3	80	10	225	55	310	8	215	160	M12	18	7500	HO VMN F09	£398.95	HO VMP F09	£584.29	HO VMQ F09	£528.77
4	100	10	295	69	350	8	250	180	M12	18	11350	HO VMN F10	£670.13	HO VMP F10	£910.85	HO VMQ F10	£935.37

with Flanges to ANSI 150

d	DN	PN	B	B ₁	H	U	H ₁	F	J	Ød	g	Product Code	List Price (£)	Product Code	List Price (£)	Product Code	List Price (£)
												EPDM		FPM		PTFE	
1/2	15	10	95	26	130	4	90	60.3	M6	15.9	740	HO VMN X02	£81.51	HO VMP X02	£88.30	HO VMQ X02	£139.92
3/4	20	10	95	26	150	4	90	69.9	M6	15.9	800	HO VMN X03	£90.98	HO VMP X03	£99.28	HO VMQ X03	£148.24
1	25	10	95	26	160	4	90	79.4	M6	15.9	890	HO VMN X04	£109.05	HO VMP X04	£119.27	HO VMQ X04	£165.87
1 1/4	32	10	126	40	180	4	115	88.9	M8	15.9	1660	HO VMN X05	£121.25	HO VMP X05	£134.70	HO VMQ X05	£212.22
1 1/2	40	10	126	40	200	4	115	98.4	M8	15.9	1775	HO VMN X06	£158.67	HO VMP X06	£176.80	HO VMQ X06	£259.52
2	50	10	148	40	230	4	140	120.7	M8	19.1	2670	HO VMN X07	£196.37	HO VMP X07	£216.55	HO VMQ X07	£321.87
2 1/2	65	10	225	55	290	4	215	139.7	M12	19.1	7100	HO VMN X08	£320.49	HO VMP X08	£511.32	HO VMQ X08	£449.75
3	80	10	225	55	310	4	215	152.4	M12	19.1	7500	HO VMN X09	£398.95	HO VMP X09	£584.29	HO VMQ X09	£528.77
4	100	10	295	69	350	8	250	190.5	M12	19.1	11350	HO VMN X10	£670.13	HO VMP X10	£910.85	HO VMQ X10	£935.37

SR BALL CHECK VALVES

with Metric series ends for socket fusion

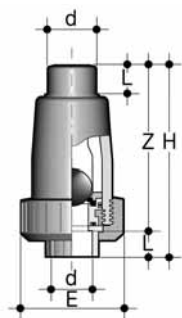

d	DN	PN	E	L	Z	H	g	Product Code	List Price (£)	Product Code	List Price (£)
								EPDM		FPM	
20	15	10	55	16	91	105	75	HO SRN 306	£45.28	HO SRP 306	£46.68
25	20	10	65	19	110	126	140	HO SRN 307	£47.94	HO SRP 307	£49.42
32	25	10	74	22	131	150	215	HO SRN 308	£52.87	HO SRP 308	£54.50
40	32	10	86	26	153	173	320	HO SRN 309	£63.59	HO SRP 309	£65.55
50	40	10	99	31	166	188	440	HO SRN 310	£68.45	HO SRP 310	£70.56
63	50	10	120	38	195	222	750	HO SRN 311	£99.61	HO SRP 311	£102.69

VR ANGLE SEAT CHECK VALVES

with unionised BS series plain female ends for socket fusion

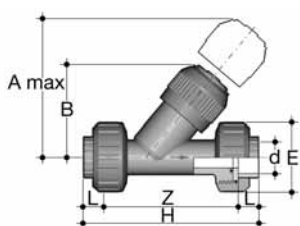

d	DN	PN	A max	B	E	Z	H	g	Product Code	List Price (£)	Product Code	List Price (£)
								EPDM		FPM		
1/2	15	10	125	71	55	108.5	137.5	165	HO URN 102	£45.28	HO URP 102	£46.68
3/4	20	10	145	83	65	125	157	227	HO URN 103	£47.94	HO URP 103	£49.42
1	25	10	165	94	74	142.5	178.5	380	HO URN 104	£52.87	HO URP 104	£54.50
1 1/4	32	10	190	109	86	164	205	645	HO URN 105	£63.72	HO URP 105	£65.69
1 1/2	40	10	210	119	99	196.5	243.5	915	HO URN 106	£71.78	HO URP 106	£74.00
2	50	10	240	142.5	120	239	294	1555	HO URN 107	£104.74	HO URP 107	£107.97

with unionised Metric series female ends for socket fusion

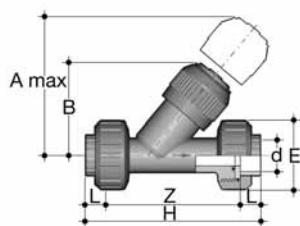

d	DN	PN	A max	B	E	Z	H	g	Product Code	List Price (£)	Product Code	List Price (£)
								EPDM		FPM		
20	15	10	125	71	55	108.5	137.5	165	HO URN 306	£45.28	HO URP 306	£46.68
25	20	10	145	83	65	125	157	227	HO URN 307	£47.94	HO URP 307	£49.42
32	25	10	165	94	74	142.5	178.5	380	HO URN 308	£52.87	HO URP 308	£54.50
40	32	10	190	109	86	164	205	645	HO URN 309	£63.72	HO URP 309	£65.69
50	40	10	210	119	99	196.5	243.5	915	HO URN 310	£71.78	HO URP 310	£74.00
63	50	10	240	142.5	120	239	294	1555	HO URN 311	£104.74	HO URP 311	£107.97

with Metric series female ends for socket fusion

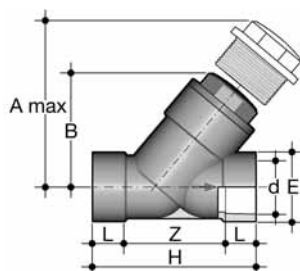

d	DN	PN	A max	B	E	Z	H	K	g	Product Code	List Price (£)	Product Code	List Price (£)
								EPDM		FPM			
75	65	6	300	176	103	179	241	96	2450	HO VRN 312	£243.82	HO VRP 312	£203.18
90	80	4	325	192	115	189	260	105	3130	HO VRN 313	£362.43	HO VRP 313	£302.03

RV SEDIMENT STRAINERS

with unionised BS series plain female ends for socket fusion

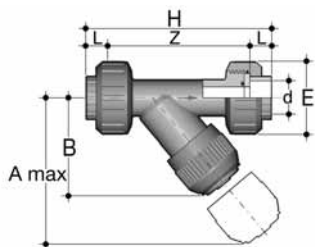

d	DN	PN	A max	B	E	Z	H	g	Product Code	List Price (£)	Product Code	List Price (£)	
										EPDM		FPM	
1/2	15	10	125	71	55	108.5	137.5	148	HO UVN 102	£38.82	HO UVP 102	£40.02	
3/4	20	10	145	83	65	125	157	195	HO UVN 103	£47.28	HO UVP 103	£48.74	
1	25	10	165	94	74	142.5	178.5	297	HO UVN 104	£61.79	HO UVP 104	£63.70	
1 1/4	32	10	190	109	86	164	205	475	HO UVN 105	£81.90	HO UVP 105	£84.43	
1 1/2	40	10	210	119	99	196.5	243.5	675	HO UVN 106	£100.05	HO UVP 106	£103.14	
2	50	10	240	142.5	120	239	294	1100	HO UVN 107	£129.84	HO UVP 107	£133.86	

with unionised Metric series plain female ends for socket fusion

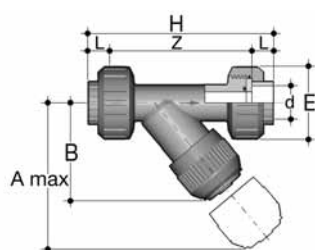

d	DN	PN	A max	B	E	Z	H	g	Product Code	List Price (£)	Product Code	List Price (£)	
										EPDM		FPM	
20	15	10	125	71	55	108.5	137.5	148	HO UVN 306	£38.82	HO UVP 306	£40.02	
25	20	10	145	83	65	125	157	195	HO UVN 307	£47.27	HO UVP 307	£48.74	
32	25	10	165	94	74	142.5	178.5	297	HO UVN 308	£61.79	HO UVP 308	£63.70	
40	32	10	190	109	86	164	205	475	HO UVN 309	£81.90	HO UVP 309	£84.43	
50	40	10	210	119	99	196.5	243.5	675	HO UVN 310	£100.05	HO UVP 310	£103.14	
63	50	10	240	142.5	120	239	294	1100	HO UVN 311	£129.84	HO UVP 311	£133.85	

with Metric series plain female ends for socket fusions

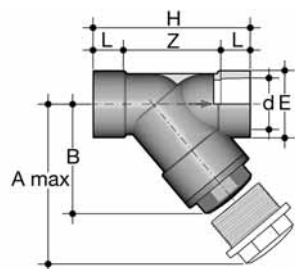

d	DN	PN	A max	B	E	Z	H	K	g	Product Code	List Price (£)	Product Code	List Price (£)
										EPDM		FPM	
75	65	6	300	176	103	179	241	96	1580	HO RVN 312	£206.77	HO RVP 312	£172.31
90	80	4	325	193	115	189	260	105	1920	HO RVN 313	£299.83	HO RVP 313	£249.85
110	100	4	385	229	138	240	323	-	3000	HO RVN 314	£522.23	HO RVP 314	£435.20

PR PRESSURE RELIEF VALVES

with BS series male ends for socket fusion

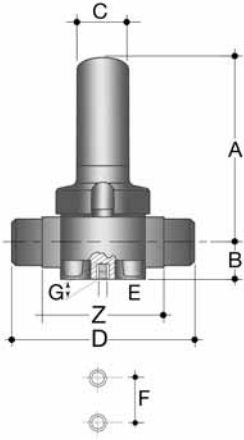

d	Z	A	B	C	D	E	F	G	kg	Product Code	List Price (£)	Product Code	List Price (£)
										EPDM		FPM	
1/2	92	143	20.5	35	124	M6	25	12	0.7	HO PRN 202	£255.35	HO PRP 202	£266.33
3/4	106	143	20.5	35	144	M6	25	12	0.7	HO PRN 203	£237.50	HO PRP 203	£300.24
1	108	143	25	35	154	M6	25	12	0.7	HO PRN 204	£295.03	HO PRP 204	£311.09
1 1/4	120	204	36	50	174	M8	44.5	16	1.5	HO PRN 205	£388.52	HO PRP 205	£357.69
1 1/2	130	204	39.5	50	194	M8	44.5	16	1.5	HO PRN 206	£396.07	HO PRP 206	£427.37
2	146	219	49	50	224	M8	44.5	16	2.4	HO PRN 207	£452.08	HO PRP 207	£489.28

with Metric series male ends for socket fusion

d	Z	A	B	C	D	E	F	G	kg	Product Code	List Price (£)	Product Code	List Price (£)
										EPDM		FPM	
20	92	143	20.5	35	124	M6	25	12	0.7	HO PRN 406	£225.84	HO PRP 406	£266.34
25	106	143	20.5	35	144	M6	25	12	0.7	HO PRN 407	£273.19	HO PRP 407	£300.51
32	108	143	25	35	154	M6	25	12	0.7	HO PRN 408	£311.09	HO PRP 408	£311.09
40	120	204	36	50	174	M8	44.5	16	1.5	HO PRN 409	£306.84	HO PRP 409	£368.47
50	130	204	39.5	50	194	M8	44.5	16	1.5	HO PRN 410	£409.26	HO PRP 410	£427.37
63	146	219	49	50	224	M8	44.5	16	2.4	HO PRN 411	£469.10	HO PRP 411	£489.28

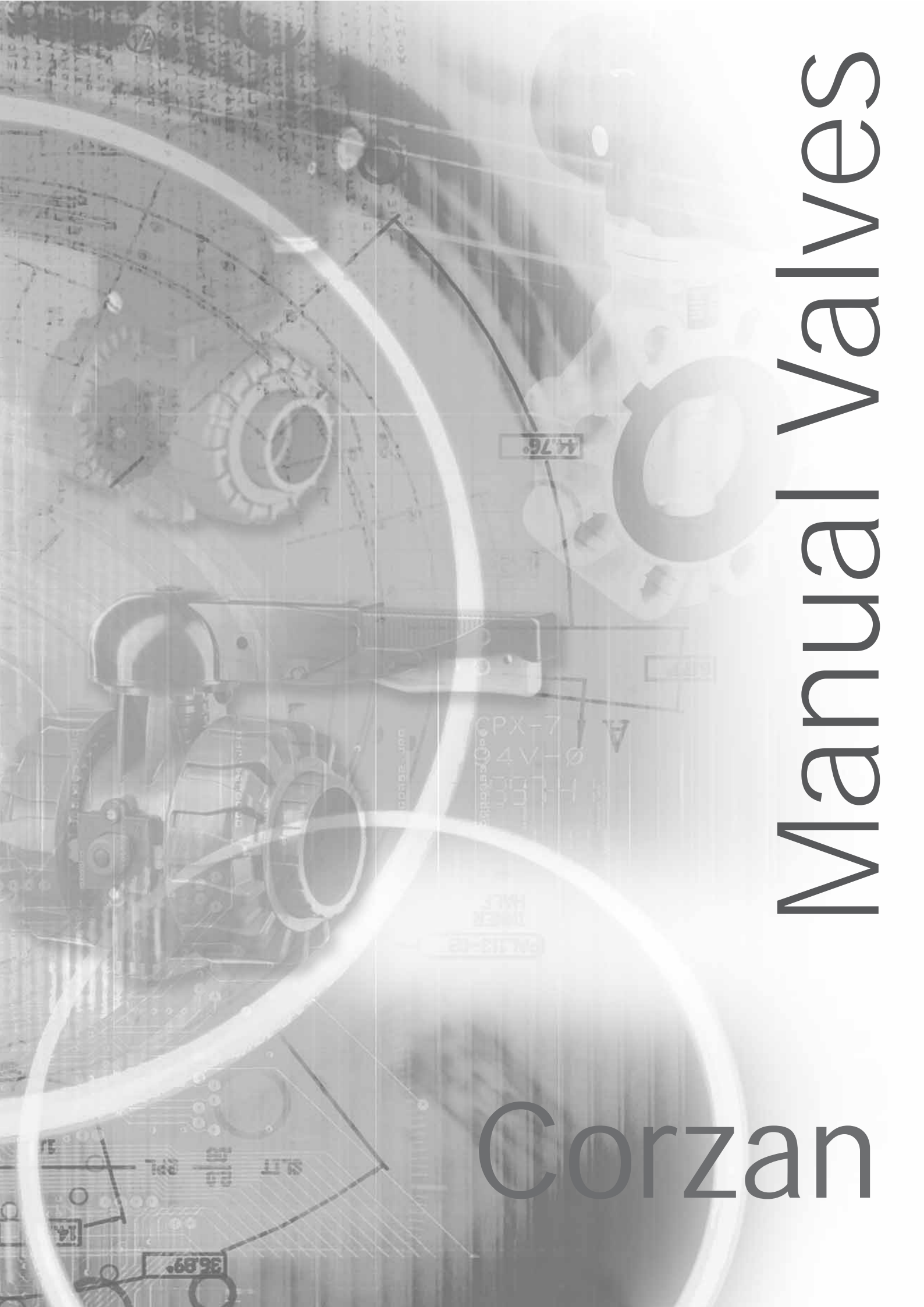

Manual Valves

Corzan

VKD DOUBLE UNION BALL VALVES (d16 to d63)

with Metric series plain female ends - Standard valve

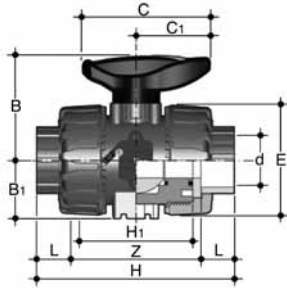

d	DN	PN	L	Z	H	H ₁	E	B	B ₁	C	C ₁	g	Product Code	List Price (£)	Product Code	List Price (£)
													EPDM		FPM	
16	10	16	14	75	103	65	54	54	29	67	40	234	H0 DKJ 305	£40.60	H0 DKK 305	£50.41
20	15	16	16	71	103	65	54	54	29	67	40	223	H0 DKJ 306	£40.81	H0 DKK 306	£50.63
25	20	16	19	77	115	70	65	65	34.5	85	49	358	H0 DKJ 307	£56.09	H0 DKK 307	£66.64
32	25	16	22	84	128	78	73	69.5	39	85	49	476	H0 DKJ 308	£63.96	H0 DKK 308	£78.57
40	32	16	26	94	146	88	86	82.5	46	108	64	753	H0 DKJ 309	£77.12	H0 DKK 309	£80.03
50	40	16	31	102	164	93	98	89	52	108	64	1007	H0 DKJ 310	£90.94	H0 DKK 310	£109.86
63	50	16	38	123	199	111	122	108	62	134	76	1717	H0 DKJ 311	£122.22	H0 DKK 311	£149.87

with Metric series plain female ends - Valve, with lockable handle

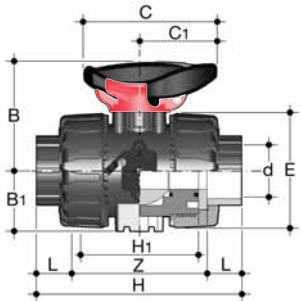

d	DN	PN	L	Z	H	H ₁	E	B	B ₁	C	C ₁	g	Product Code	List Price (£)	Product Code	List Price (£)
													EPDM		FPM	
16	10	16	14	75	103	65	54	54	29	67	40	234	H0 DLJ 305	£51.01	H0 DLK 305	£60.09
20	15	16	16	71	103	65	54	54	29	67	40	223	H0 DLJ 306	£51.20	H0 DLK 306	£60.29
25	20	16	19	77	115	70	65	65	34.5	85	49	358	H0 DLJ 307	£66.93	H0 DLK 307	£76.69
32	25	16	22	84	128	78	73	69.5	39	85	49	476	H0 DLJ 308	£74.21	H0 DLK 308	£87.74
40	32	16	26	94	146	88	86	82.5	46	108	64	753	H0 DLJ 309	£88.76	H0 DLK 309	£91.46
50	40	16	31	102	164	93	98	89	52	108	64	1007	H0 DLJ 310	£101.56	H0 DLK 310	£119.08
63	50	16	38	123	199	111	122	108	62	134	76	1717	H0 DLJ 311	£131.78	H0 DLK 311	£157.39

with Flanged ends BS4504 PN10 - Standard valve

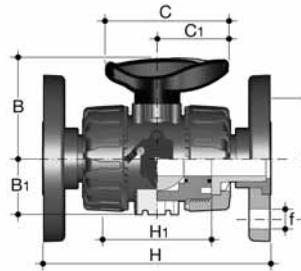

d	DN	PN	H	H ₁	B	B ₁	C	C ₁	F	f	U	g	Product Code	List Price (£)	Product Code	List Price (£)
													EPDM		FPM	
20	15	16	130	65	54	29	67	40	65	14	4	481.1	H0 DKJ F02	£96.43	H0 DKK F02	£106.25
25	20	16	150	70	65	34.5	85	49	75	14	4	663.1	H0 DKJ F03	£123.03	H0 DKK F03	£133.58
32	25	16	160	78	69.5	39	85	49	85	14	4	895.9	H0 DKJ F04	£137.86	H0 DKK F04	£152.48
40	32	16	180	88	82.5	46	108	64	100	18	4	1379	H0 DKJ F05	£148.42	H0 DKK F05	£151.33
50	40	16	200	93	89	52	108	64	110	18	4	1761	H0 DKJ F06	£184.97	H0 DKK F06	£203.89
63	50	16	230	111	108	62	134	76	134	18	4	2741	H0 DKJ F07	£239.74	H0 DKK F07	£267.38

with Flanged ends BS4504 PN10 - Valve, with lockable handle

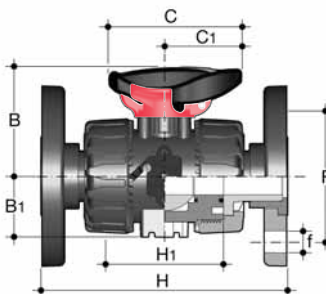

d	DN	PN	H	H ₁	B	B ₁	C	C ₁	F	f	U	g	Product Code	List Price (£)	Product Code	List Price (£)
													EPDM		FPM	
20	15	16	130	65	54	29	67	40	65	14	4	481.1	H0 DLJ F02	£110.91	H0 DLK F02	£120.74
25	20	16	150	70	65	34.5	85	49	75	14	4	663.1	H0 DLJ F03	£139.22	H0 DLK F03	£149.77
32	25	16	160	78	69.5	39	85	49	85	14	4	895.9	H0 DLJ F04	£154.05	H0 DLK F04	£168.67
40	32	16	180	88	82.5	46	108	64	100	18	4	1379	H0 DLJ F05	£167.16	H0 DLK F05	£170.07
50	40	16	200	93	89	52	108	64	110	18	4	1761	H0 DLJ F06	£203.71	H0 DLK F06	£222.63
63	50	16	230	111	108	62	134	76	134	18	4	2741	H0 DLJ F07	£259.85	H0 DLK F07	£287.49

VKD DOUBLE UNION BALL VALVES (d16 to d63)

with Flanged ends ANSI 150 - Standard valve

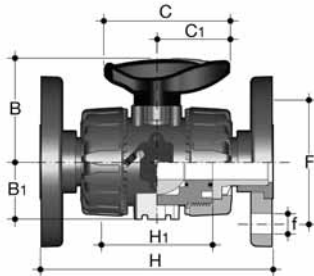

d	DN	PN	H	H ₁	B	B ₁	C	C ₁	F	f	U	g	Product Code	List Price (£)	Product Code	List Price (£)
													EPDM		FPM	
20	15	16	130	65	54	29	67	40	65	14	4	481.1	HO DKJ X02	£100.75	HO DKK X02	£110.58
25	20	16	150	70	65	34.5	85	49	75	14	4	663.1	HO DKJ X03	£118.81	HO DKK X03	£129.35
32	25	16	160	78	69.5	39	85	49	85	14	4	895.9	HO DKJ X04	£135.03	HO DKK X04	£149.65
40	32	16	180	88	82.5	46	108	64	100	18	4	1379	HO DKJ X05	£148.42	HO DKK X05	£151.33
50	40	16	200	93	89	52	108	64	110	18	4	1761	HO DKJ X06	£185.03	HO DKK X06	£203.94
63	50	16	230	111	108	62	134	76	134	18	4	2741	HO DKJ X07	£236.22	HO DKK X07	£263.86

with Flanged ends ANSI 150 - Valve, with lockable handle

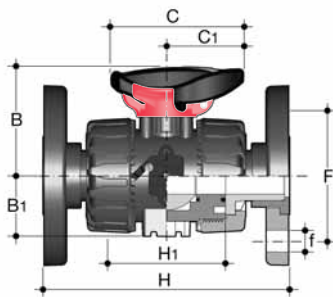

d	DN	PN	H	H ₁	B	B ₁	C	C ₁	F	f	U	g	Product Code	List Price (£)	Product Code	List Price (£)
													EPDM		FPM	
20	15	16	130	65	54	29	67	40	65	14	4	481.1	HO DLJ X02	£115.24	HO DLK X02	£125.06
25	20	16	150	70	65	34.5	85	49	75	14	4	663.1	HO DLJ X03	£135.00	HO DLK X03	£145.54
32	25	16	160	78	69.5	39	85	49	85	14	4	895.9	HO DLJ X04	£151.22	HO DLK X04	£165.84
40	32	16	180	88	82.5	46	108	64	100	18	4	1379	HO DLJ X05	£167.16	HO DLK X05	£170.07
50	40	16	200	93	89	52	108	64	110	18	4	1761	HO DLJ X06	£203.77	HO DLK X06	£222.68
63	50	16	230	111	108	62	134	76	134	18	4	2741	HO DLJ X07	£256.33	HO DLK X07	£283.97

VKD 2-WAY BALL VALVES

with Metric series plain female

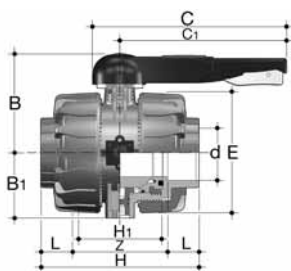

d	DN	PN	Z	L	H	H ₁	E	B	B ₁	C	C ₁	g	Product Code	List Price (£)	Product Code	List Price (£)
													EPDM		FPM	
75	65	16	147	44	235	133	164	164	87	225	175	4380	HO DKJ 312	£336.87	HO DKK 312	£410.53
90	80	16	168	51	270	149	203	177	105	327	272	7200	HO DKJ 313	£420.34	HO DKK 313	£504.80
110	100	16	186	61	308	167	238	195	129	385	330	11141	HO DKJ 314	£549.98	HO DKK 314	£612.84

with BS4504 PN10/ANSI 150 backing rings

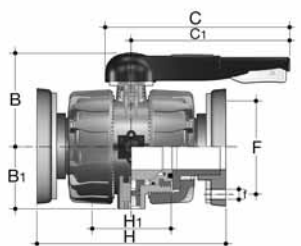

d	DN	PN	H	H ₁	B	B ₁	C	C ₁	f	F	g	Product Code	List Price (£)	Product Code	List Price (£)	
													EPDM		FPM	
75	65	16	290	133	164	87	225	175	17	145	6610	HO DKJ X08	£497.71	HO DKK X08	£606.53	
90	80	16	310	149	177	105	327	272	17	160	9330	HO DKJ X09	£621.02	HO DKK X09	£745.82	
110	100	16	350	167	195	129	385	330	17	180	13815	HO DKJ X10	£812.56	HO DKK X10	£905.43	

TKD 3-WAY BALL VALVES



with Metric series plain female ends for solvent welding (T Port)

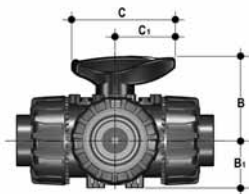

d	DN	PN	H	Z	C	C1	B	B1	g	Product Code	List Price (£)	Product Code	List Price (£)
										EPDM	FPM	EPDM	FPM
20	15	16	118	86	67	40	54	29	310	HO TTJ 306	£101.23	HO TTK 306	£109.56
25	20	16	145	107	85	49	65	34.5	550	HO TTJ 307	£109.81	HO TTK 307	£120.92
32	25	16	160	116	85	49	65.9	39	790	HO TTJ 308	£131.45	HO TTK 308	£145.23
40	32	16	188.5	136.5	108	64	82.5	46	1275	HO TTJ 309	£162.69	HO TTK 309	£182.63
50	40	16	219	157	108	64	89	52	1660	HO TTJ 310	£180.94	HO TTK 310	£214.40
63	50	16	266.5	190.5	134	76	108	62	2800	HO TTJ 311	£230.15	HO TTK 311	£272.38

with Metric series plain female ends for solvent welding (L Port)

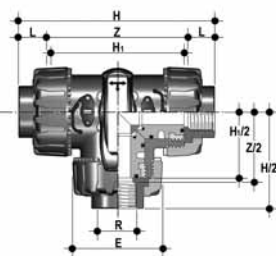

d	DN	PN	H	Z	C	C1	B	B1	g	Product Code	List Price (£)	Product Code	List Price (£)
										EPDM	FPM	EPDM	FPM
20	15	16	118	86	67	40	54	29	310	HO LTJ 306	£101.23	HO LTK 306	£109.56
25	20	16	145	107	85	49	65	34.5	550	HO LTJ 307	£109.81	HO LTK 307	£120.92
32	25	16	160	116	85	49	65.9	39	790	HO LTJ 308	£131.45	HO LTK 308	£145.23
40	32	16	188.5	136.5	108	64	82.5	46	1275	HO LTJ 309	£162.69	HO LTK 309	£182.63
50	40	16	219	157	108	64	89	52	1660	HO LTJ 310	£180.94	HO LTK 310	£214.40
63	50	16	266.5	190.5	134	76	108	62	2800	HO LTJ 311	£230.15	HO LTK 311	£272.38

See page 79 for a full list of TKD accessories.

BALL VALVE ACCESSORIES

End connectors in PE- VKD, VX, VE, VT, SK, long spigot, for electrofusion or butt weld

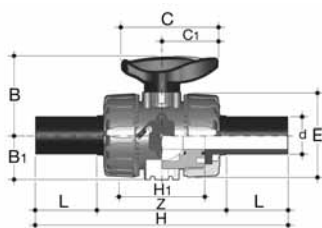
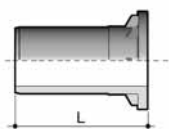

d	DN	L	H	Product Code	List Price (£)
20	15	55	175	HZ PEE M06	£5.25
25	20	70	210	HZ PEE M07	£5.37
32	25	74	224	HZ PEE M08	£5.49
40	32	78	243	HZ PEE M09	£8.53
50	40	84	261	HZ PEE M10	£10.14
63	50	91	293	HZ PEE M11	£14.37
75	65	111	356	HZ PEE M12	POA
90	80	118	390	HZ PEE M13	POA
110	100	132	432	HZ PEE M14	POA

End connectors in PP- VKD, VX, VE, VT, SK, long spigot, for electrofusion or butt weld

d	DN	L	H	Product Code	List Price (£)
20	15	55	175	HZ PPE M06	£4.48
25	20	70	210	HZ PPE M07	£5.27
32	25	74	224	HZ PPE M08	£6.46
40	32	78	243	HZ PPE M09	£8.05
50	40	84	261	HZ PPE M10	£10.44
63	50	91	293	HZ PPE M11	£13.45
75	65	111	356	HZ PPE M12	£27.17
90	80	118	390	HZ PPE M13	£34.18
110	100	132	432	HZ PPE M14	£41.41

FK BUTTERFLY VALVES - GRPP BODY WITH CORZAN DISC

Lever operated - PN10/ANSI/BS10

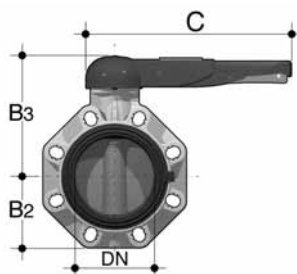

d	DN	PN	B2	B3	C	C1	Z	g	U	Product Code	List Price (£)	Product Code	List Price (£)
										EPDM		FPM	
50	40	16	60	137	175	100	33	900	4	HO FKJ 106	£148.37	HO FKK 106	£179.42
63	50	16	70	143	175	100	43	1080	4	HO FKJ 107	£156.50	HO FKK 107	£190.11
75	65	10	80	164	272	110	46	1470	4	HO FKJ 108	£169.60	HO FKK 108	£202.30
90	80	10	93	178	272	110	49	1870	8	HO FKJ 109	£188.57	HO FKK 109	£215.18
110	100	10	107	192	272	110	56	2220	8	HO FKJ 110	£225.37	HO FKK 110	£254.46
160	150	10	134	225	330	110	70	3850	8	HO FKJ 112	£353.66	HO FKK 112	£389.47



Lever operated - LUGGED BS 4504, PN10

d	DN	PN	B2	B3	C	C1	Z	g	U	Product Code	List Price (£)	Product Code	List Price (£)
										EPDM		FPM	
75	65	10	80	164	272	110	46	1470	4	HO FKJ F08	£264.10	HO FKK F08	£324.35
90	80	10	93	178	272	110	49	1870	8	HO FKJ F09	£309.29	HO FKK F09	£376.91
110	100	10	107	192	272	110	56	2220	8	HO FKJ F10	£375.70	HO FKK F10	£476.61
160	150	10	134	225	330	110	70	3850	8	HO FKJ F12	£571.83	HO FKK F12	£745.17

Suitable for end of line applications

Lever operated - LUGGED ANSI 150

d	DN	PN	B2	B3	C	C1	Z	g	U	Product Code	List Price (£)	Product Code	List Price (£)
										EPDM		FPM	
75	65	10	80	164	272	110	46	1470	4	HO FKJ X08	£301.89	HO FKK X08	£358.65
90	80	10	93	178	272	110	49	1870	8	HO FKJ X09	£350.49	HO FKK X09	£414.26
110	100	10	107	192	272	110	56	2220	8	HO FKJ X10	£426.03	HO FKK X10	£522.93
160	150	10	134	225	330	110	70	3850	8	HO FKJ X12	£648.41	HO FKK X12	£817.36

Suitable for end of line applications

FK BUTTERFLY VALVES - GRPP BODY WITH CORZAN DISC

Gear box operated - PN10/ANSI/BS10

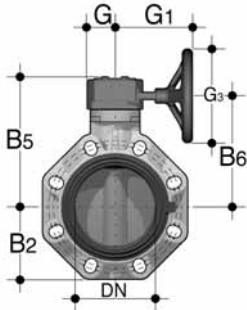

d	DN	PN	B2	B5	B6	G	G1	G2	G3	Z	g	U	Product Code	List Price (£)	Product Code	List Price (£)
													EPDM		FPM	
63	65	10	80	174	146	48	135	39	125	46	2400	4	HV FKJ 108	£380.97	HV FKK 108	£413.67
90	80	10	93	188	160	48	135	39	125	49	2800	8	HV FKJ 109	£399.94	HV FKK 109	£426.55
110	100	10	107	202	174	48	135	39	125	56	3150	8	HV FKJ 110	£436.72	HV FKK 110	£465.83
160	150	10	134	235	207	48	144	39	200	70	5200	8	HV FKJ 112	£565.03	HV FKK 112	£600.84

Gear box operated - LUGGED BS 4504, PN10



d	DN	PN	B2	B5	B6	G	G1	G2	G3	Z	g	U	Product Code	List Price (£)	Product Code	List Price (£)
													EPDM		FPM	
75	65	10	80	174	146	48	135	39	125	46	2400	4	HV FKJ F08	£514.40	HV FKK F08	£551.45
90	80	10	93	188	160	48	135	39	125	49	2800	8	HV FKJ F09	£561.77	HV FKK F09	£605.85
110	100	10	107	202	174	48	135	39	125	56	3150	8	HV FKJ F10	£624.88	HV FKK F10	£705.92
160	150	10	134	235	207	48	144	39	200	70	5200	8	HV FKJ F12	£817.43	HV FKK F12	£976.75

Suitable for end of line applications

Gear box operated - LUGGED ANSI 150

d	DN	PN	B2	B5	B6	G	G1	G2	G3	Z	g	U	Product Code	List Price (£)	Product Code	List Price (£)
													EPDM		FPM	
75	65	10	80	174	146	48	135	39	125	46	2400	4	HV FKJ X08	£552.18	HV FKK X08	£585.73
90	80	10	93	188	160	48	135	39	125	49	2800	8	HV FKJ X09	£602.98	HV FKK X09	£643.22
110	100	10	107	202	174	48	135	39	125	56	3150	8	HV FKJ X10	£675.20	HV FKK X10	£752.25
160	150	10	134	235	207	48	144	39	200	70	5200	8	HV FKJ X12	£894.01	HV FKK X12	£1,048.94

Suitable for end of line applications

VM DIAPHRAGM VALVES

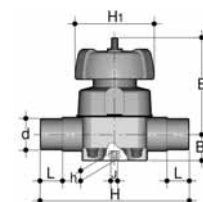

with Metric series plain male ends

d	DN	PN	B	B ₁	H	h	H ₁	I	J	L	g	Product Code	List Price (£)	Product Code	List Price (£)	Product Code	List Price (£)			
												EPDM			FPM			PTFE		
20	15	10	95	26	124	12	90	25	M6	16	720	HO VMJ 406	£71.61	HO VMK 406	£118.32	HO VML 406	£132.64			
25	20	10	95	26	144	12	90	25	M6	19	720	HO VMJ 407	£80.95	HO VMK 407	£128.44	HO VML 407	£141.05			
32	25	10	95	26	154	12	90	25	M6	23	720	HO VMJ 408	£86.42	HO VMK 408	£137.01	HO VML 408	£153.21			
40	32	10	126	40	174	18	115	44.5	M8	27	1560	HO VMJ 409	£101.19	HO VMK 409	£193.04	HO VML 409	£196.93			
50	40	10	126	40	194	18	115	44.5	M8	32	1560	HO VMJ 410	£141.67	HO VMK 410	£241.30	HO VML 410	£241.45			
63	50	10	148	40	224	18	140	44.5	M8	39	2500	HO VMJ 411	£172.81	HO VMK 411	£305.14	HO VML 411	£314.17			
75	65	10	225	55	284	23	215	100	M12	44	7260	HO VMJ 412	£296.33	HO VMK 412	£423.68	HO VML 412	£504.56			
90	80	10	225	55	300	23	215	100	M12	51	7260	HO VMJ 413	£420.35	HO VMK 413	£569.79	HO VML 413	£664.76			
110	100*	10	295	69	350	23	250	120	M12	-	10860	HO VMJ 414	£638.30	HO VMK 414	£755.06	HO VML 414	£924.75			

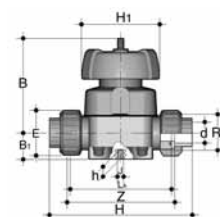

with unionised Metric series plain female ends

d	DN	PN	B	B ₁	H	h	H ₁	LA	J	LB	R1	g	Product Code	List Price (£)	Product Code	List Price (£)	Product Code	List Price (£)		
												EPDM			FPM			PTFE		
20	15	10	95	20.5	146	12	90	108	M6	114	1	860	HO UMJ 306	£99.04	HO UMK 306	£177.82	HO UML 306	£177.82		
25	20	10	95	20.5	152	12	90	108	M6	114	1 1/4	895	HO UMJ 307	£110.64	HO UMK 307	£193.39	HO UML 307	£193.39		
32	25	10	95	25	166	12	90	116	M6	122	1 1/2	930	HO UMJ 308	£128.18	HO UMK 308	£207.38	HO UML 308	£207.38		
40	32	10	126	36	192	16	115	134	M8	140	2	1720	HO UMJ 309	£158.39	HO UMK 309	£278.42	HO UML 309	£278.42		
50	40	10	126	39.5	222	16	115	154	M8	160	2 1/4	1800	HO UMJ 310	£198.07	HO UMK 310	£316.86	HO UML 310	£316.86		
63	50	10	148	49	266	16	140	184	M8	190	2 3/4	2915	HO UMJ 311	£244.67	HO UMK 311	£441.51	HO UML 311	£441.51		

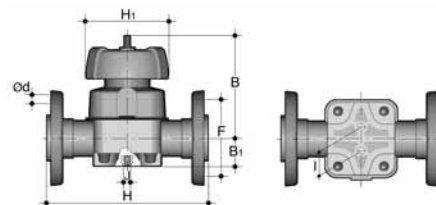

with Flanges to BS 4504 PN10

d	DN	PN	B	B ₁	H	U	H ₁	F	J	Ød	g	Product Code	List Price (£)	Product Code	List Price (£)	Product Code	List Price (£)			
												EPDM			FPM			PTFE		
20	15	10	95	26	130	4	90	65	M6	14	910	HO VMJ F06	£123.60	HO VMK F06	£170.30	HO VML F06	£184.62			
25	20	10	95	26	150	4	90	75	M6	14	970	HO VMJ F07	£139.99	HO VMK F07	£187.49	HO VML F07	£200.09			
32	25	10	95	26	160	4	90	85	M6	14	1060	HO VMJ F08	£150.85	HO VMK F08	£201.44	HO VML F08	£217.64			
40	32	10	126	40	180	4	115	100	M8	18	2120	HO VMJ F09	£160.56	HO VMK F09	£252.41	HO VML F09	£256.30			
50	40	10	126	40	200	4	115	110	M8	18	2225	HO VMJ F10	£221.44	HO VMK F10	£321.07	HO VML F10	£321.22			
63	50	10	148	40	230	4	140	125	M8	18	3320	HO VMJ F11	£273.47	HO VMK F11	£405.79	HO VML F11	£414.82			
75	65	10	225	55	290	4	215	145	M12	18	8500	HO VMJ F12	£400.78	HO VMK F12	£528.13	HO VML F12	£609.01			
90	80	10	225	55	310	8	215	160	M12	18	9150	HO VMJ F13	£557.10	HO VMK F13	£706.56	HO VML F13	£801.52			
110	100	10	295	69	350	8	250	180	M12	18	13200	HO VMJ F14	£803.14	HO VMK F14	£919.90	HO VML F14	£1,089.59			

with Flanges to ANSI 150

d	DN	PN	B	B ₁	H	U	H ₁	F	J	Ød	g	Product Code	List Price (£)	Product Code	List Price (£)	Product Code	List Price (£)			
												EPDM			FPM			PTFE		
20	15	10	95	26	130	4	90	60.3	M6	15.9	910	HO VMJ X06	£128.22	HO VMK X06	£174.93	HO VML X06	£189.25			
25	20	10	95	26	150	4	90	69.9	M6	15.9	970	HO VMJ X07	£135.47	HO VMK X07	£182.96	HO VML X07	£195.57			
32	25	10	95	26	160	4	90	79.4	M6	15.9	1060	HO VMJ X08	£147.82	HO VMK X08	£198.41	HO VML X08	£214.62			
40	32	10	126	40	180	4	115	88.9	M8	15.9	2120	HO VMJ X09	£160.56	HO VMK X09	£252.41	HO VML X09	£256.30			
50	40	10	126	40	200	4	115	98.4	M8	15.9	2225	HO VMJ X10	£221.50	HO VMK X10	£321.13	HO VML X10	£321.28			
63	50	10	148	40	230	4	140	120.7	M8	19.1	3320	HO VMJ X11	£269.70	HO VMK X11	£402.03	HO VML X11	£411.06			
75	65	10	225	55	290	4	215	139.7	M12	19.1	8500	HO VMJ X12	£407.22	HO VMK X12	£534.57	HO VML X12	£615.45			
90	80	10	225	55	310	4	215	152.4	M12	19.1	9150	HO VMJ X13	£558.27	HO VMK X13	£707.73	HO VML X13	£802.69			
110	100	10	295	69	350	8	250	190.5	M12	19.1	13200	HO VMJ X14	£807.59	HO VMK X14	£924.35	HO VML X14	£1,094.04			

SR BALL CHECK VALVES

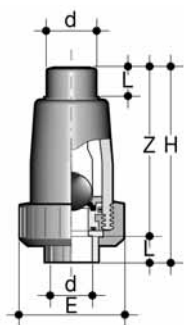

with Metric series ends for solvent welding

d	DN	PN	E	L	Z	H	g	Product Code	List Price (£)	Product Code	List Price (£)	
									EPDM		FPM	
20	15	16	55	16	86	102	120	HO SRJ 306	£45.00	HO SRK 306	£46.67	
25	20	16	66	19	105	124	225	HO SRJ 307	£52.86	HO SRK 307	£51.80	
32	25	16	75	22	127	149	340	HO SRJ 308	£64.62	HO SRK 308	£67.45	
40	32	16	87	26	146	172	520	HO SRJ 309	£93.41	HO SRK 309	£98.76	
50	40	16	100	31	156	187	720	HO SRJ 310	£98.08	HO SRK 310	£103.06	
63	50	16	120	38	186	224	1125	HO SRJ 311	£123.77	HO SRK 311	£124.40	

UV SEDIMENT STRAINERS

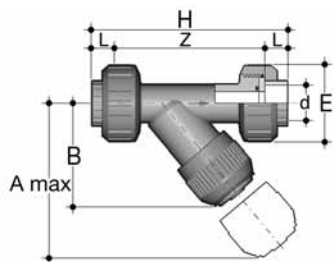

with unionised Metric series plain female ends for solvent welding

d	DN	PN	A max	B	E	L	Z	H	Fig.	g	Product Code	List Price (£)	Product Code	List Price (£)	
												EPDM		FPM	
20	15	16	125	72	55	16	103	135	A	231	HO UVJ 306	£73.44	HO UVK 306	£84.53	
25	20	16	145	84	66	19	120	158	A	392	HO UVJ 307	£79.67	HO UVK 307	£96.99	
32	25	16	165	95	75	22	132	176	A	576	HO UVJ 308	£94.23	HO UVK 308	£118.48	
40	32	16	190	111	87	26	155	207	A	802	HO UVJ 309	£128.87	HO UVK 309	£155.89	
50	40	16	210	120	100	31	181	243	A	1199	HO UVJ 310	£163.51	HO UVK 310	£224.48	
63	50	16	240	139	120	38	222	298	A	2018	HO UVJ 311	£227.25	HO UVK 311	£248.03	

PR PRESSURE RELIEF VALVES

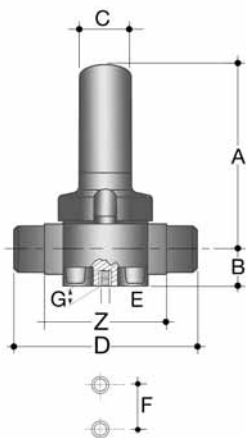

with Metric series male ends for solvent welding

d	Z	A	B	C	D	E	F	G	kg	Product Code	List Price (£)	Product Code	List Price (£)	
											EPDM		FPM	
20	92	143	20.5	35	124	M6	25	12	0.7	HO PRJ 406	£264.67	HO PRK 406	£291.12	
25	106	143	20.5	35	144	M6	25	12	0.7	HO PRJ 407	£288.02	HO PRK 407	£316.82	
32	108	143	25	35	154	M6	25	12	0.7	HO PRJ 408	£311.36	HO PRK 408	£342.50	
40	120	204	36	50	174	M8	44.5	16	1.5	HO PRJ 409	£373.64	HO PRK 409	£411.00	
50	130	204	39.5	50	194	M8	44.5	16	1.5	HO PRJ 410	£435.91	HO PRK 410	£479.50	
63	146	219	49	50	224	M8	44.5	16	2.4	HO PRJ 411	£498.18	HO PRK 411	£548.00	

Actuated Valves



Understanding actuated codes and pricing

Firstly establish the specification of the type of actuation that is needed. In the example below this is a H1 DK* ***, an electric actuated double union ball valve (VKD). Once the actuation required has been identified, make a note of the list price.

Now the code needs finalising to identify the full specification of the manual valve, i.e. material of the body, size etc. In the appropriate Manual section of this price list, find the code associated with the product needed. In this example it will be found under double union ball valves (VKD) in the ABS section. This will give a code similar to HO DKB 106, a 1½" double union ball valve in ABS with FPM seals, where the 1st, 3rd and 4th characters will be the same as the actuated code already identified, in this instance HDK. Again make a note of the list price.

Now combine the codes. Use the first 4 digits of the actuated code together with the last 4 of the manual code. This will give a unique 8 digit code, in this instance H1DKB106, with the cost being the sum of the manual and actuated list prices, e.g. (£116.93 + £320.76 = £437.69).

For further explanation on how the coding system works, refer to the table on page 5 or alternatively contact our Valve Department on 01543 272424.

Durapipe FIP valves are coded in a simple and logical manner, each box containing information about the valve required:

Example:

H	1	D	K	B	1	0	6
---	---	---	---	---	---	---	---

- H** = Prefixes all valve orders
- 1** = Type of operation/actuator
In this example: Electrical 100 to 240v
- D K** = Type of valve
In this example: VKD Double union ball
- B** = Body and seals details
In this example: ABS body with FPM seals
- 1 0 6** = Valve size
In this example: to suit a pipe of 1½" nominal bore

To order, simply select the appropriate combination from page 4 or page 76 in this catalogue.

Valve type	Actuation available	
	Electrical	Pneumatic
Butterfly	*	*
Diaphragm		*
Ball	*	*
Angle seat		*

Durapipe FIP Manual and Actuated valves pricing method

Below is an example of how to calculate the price of a manual and actuated valve combination:

Manual valve				Actuated valve					
Description	Product Code	Page Number	Price Each (£)	Description	Product Code	Page Number	Price Each (£)	Combined Code	Total Price (£)
1½" ABS VKD double union ball valve with FPM seals	HO DKB 106	34	£116.93	VKD Electric Actuated - Standard 100 to 240v AC	H1 DK	65	£320.76	HI DKB 106	£437.69

VKD DOUBLE UNION BALL VALVES

3/8" -d16 to 2"-d63

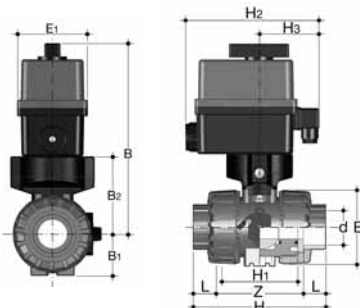

2 1/2" -d75 to 4"-d110

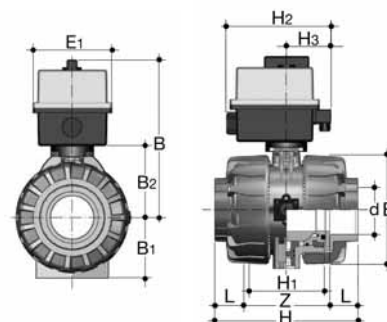

VKD Electric actuated - Standard

G	d	DN	PN*	B	H	B1	B2	E1	H2	H3	ACT	Product Code	List Price (£)	Product Code	List Price (£)
												100 to 240 v AC		24 v AC/DC	
3/8	16	10	16	205	103	29	58	92	187	82	EA2	H1 DK* ***	£320.76	H2 DK* ***	£320.76
1/2	20	15	16	205	103	29	58	92	187	82	EA2	H1 DK* ***	£320.76	H2 DK* ***	£320.76
3/4	25	20	16	220.5	115	34.5	73.5	92	187	82	EA2	H1 DK* ***	£320.76	H2 DK* ***	£320.76
1	32	25	16	221	128	39	74	92	187	82	EA2	H1 DK* ***	£320.76	H2 DK* ***	£320.76
1 1/4	40	32	16	244	146	46	97	92	187	82	EA2	H1 DK* ***	£320.76	H2 DK* ***	£320.76
1 1/2	50	40	16	251	164	52	104	92	187	82	EA2	H1 DK* ***	£320.76	H2 DK* ***	£320.76
2	63	50	10**	261	199	62	114	92	187	82	EA2	H1 DK* ***	£320.76	H2 DK* ***	£320.76
2 1/2	75	65	16	295	235	87	119	128	188	93	EA3	H1 DK* ***	£428.76	H2 DK* ***	£428.76
3	90	80	16	308	270	105	132	128	188	93	EA3	H1 DK* ***	£428.76	H2 DK* ***	£428.76
4	110	100	10**	325	308	129	150	128	188	93	EA3	H1 DK* ***	£428.76	H2 DK* ***	£428.76

VKD Electrically Actuated - Fail safe closed

G	d	DN	PN*	B	H	B1	B2	E1	H2	H3	ACT	Product Code	List Price (£)	Product Code	List Price (£)
												100 to 240 v AC		24 v AC/DC	
3/8	16	10	16	205	103	29	58	92	187	82	EB2	H3 DK* ***	£459.00	H4 DK* ***	£459.00
1/2	20	15	16	205	103	29	58	92	187	82	EB2	H3 DK* ***	£459.00	H4 DK* ***	£459.00
3/4	25	20	16	220.5	115	34.5	73.5	92	187	82	EB2	H3 DK* ***	£459.00	H4 DK* ***	£459.00
1	32	25	16	221	128	39	74	92	187	82	EB2	H3 DK* ***	£459.00	H4 DK* ***	£459.00
1 1/4	40	32	16	244	146	46	97	92	187	82	EB2	H3 DK* ***	£459.00	H4 DK* ***	£459.00
1 1/2	50	40	16	251	164	52	104	92	187	82	EB2	H3 DK* ***	£459.00	H4 DK* ***	£459.00
2	63	50	10**	261	199	62	114	92	187	82	EB2	H3 DK* ***	£459.00	H4 DK* ***	£459.00
2 1/2	75	65	16	295	235	87	119	128	188	93	EB3	H3 DK* ***	£569.16	H4 DK* ***	£569.16
3	90	80	16	308	270	105	132	128	188	93	EB3	H3 DK* ***	£569.16	H4 DK* ***	£569.16
4	110	100	10**	325	308	129	150	128	188	93	EB3	H3 DK* ***	£569.16	H4 DK* ***	£569.16

VKD Electrically Actuated - Fail safe open

G	d	DN	PN*	B	H	B1	B2	E1	H2	H3	ACT	Product Code	List Price (£)	Product Code	List Price (£)
												100 to 240 v AC		24 v AC/DC	
3/8	16	10	16	205	103	29	58	92	187	82	EB2	H5 DK* ***	£459.00	H6 DK* ***	£459.00
1/2	20	15	16	205	103	29	58	92	187	82	EB2	H5 DK* ***	£459.00	H6 DK* ***	£459.00
3/4	25	20	16	220.5	115	34.5	73.5	92	187	82	EB2	H5 DK* ***	£459.00	H6 DK* ***	£459.00
1	32	25	16	221	128	39	74	92	187	82	EB2	H5 DK* ***	£459.00	H6 DK* ***	£459.00
1 1/4	40	32	16	244	146	46	97	92	187	82	EB2	H5 DK* ***	£459.00	H6 DK* ***	£459.00
1 1/2	50	40	16	251	164	52	104	92	187	82	EB2	H5 DK* ***	£459.00	H6 DK* ***	£459.00
2	63	50	10**	261	199	62	114	92	187	82	EB2	H5 DK* ***	£459.00	H6 DK* ***	£459.00
2 1/2	75	65	16	295	235	87	119	128	188	93	EB3	H5 DK* ***	£569.16	H6 DK* ***	£569.16
3	90	80	16	308	270	105	132	128	188	93	EB3	H5 DK* ***	£569.16	H6 DK* ***	£569.16
4	110	100	10**	325	308	129	150	128	188	93	EB3	H5 DK* ***	£569.16	H6 DK* ***	£569.16

VKD Electrically Actuated - 4 to 20mA Positioning

G	d	DN	PN*	B	H	B1	B2	E1	H2	H3	ACT	Product Code	List Price (£)	Product Code	List Price (£)
												100 to 240 v AC		24 v AC/DC	
3/8	16	10	16	205	103	29	58	92	187	82	EM2	H7 DK* ***	£491.40	H8 DK* ***	£491.40
1/2	20	15	16	205	103	29	58	92	187	82	EM2	H7 DK* ***	£491.40	H8 DK* ***	£491.40
3/4	25	20	16	220.5	115	34.5	73.5	92	187	82	EM2	H7 DK* ***	£491.40	H8 DK* ***	£491.40
1	32	25	16	221	128	39	74	92	187	82	EM2	H7 DK* ***	£491.40	H8 DK* ***	£491.40
1 1/4	40	32	16	244	146	46	97	92	187	82	EM2	H7 DK* ***	£491.40	H8 DK* ***	£491.40
1 1/2	50	40	16	251	164	52	104	92	187	82	EM2	H7 DK* ***	£491.40	H8 DK* ***	£491.40
2	63	50	10**	261	199	62	114	92	187	82	EM2	H7 DK* ***	£491.40	H8 DK* ***	£491.40
2 1/2	75	65	16	295	235	87	119	128	188	93	EM3	H7 DK* ***	£601.56	H8 DK* ***	£601.56
3	90	80	16	308	270	105	132	128	188	93	EM3	H7 DK* ***	£601.56	H8 DK* ***	£601.56
4	110	100	10**	325	308	129	150	128	188	93	EM3	H7 DK* ***	£601.56	H8 DK* ***	£601.56

* PP PN 10 bar

Actuated valve prices are calculated by adding the above prices to the relevant manual valve prices, see page 64 for example.

** DN50/DN100 PN16 available on request

VKD DOUBLE UNION BALL VALVES

3/8" -d16 to 2"-d63

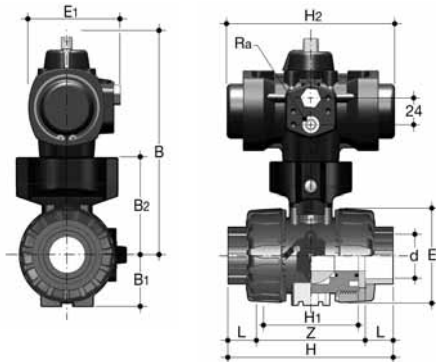

2 1/2" -d75 to 4"-d110

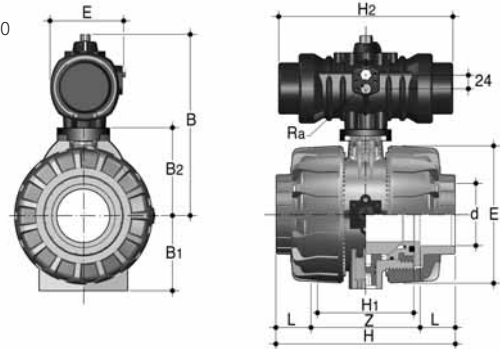

VKD Pneumatically Actuated - Fail safe closed

G	d	DN	PN*	B	H	B1	B2	E1	H2	ACT	Product Code	List Price (£)
3/8	16	10	16	143	103	29	58	68.5	142	PA1/S	HP DK* ***	£174.96
1/2	20	15	16	143	103	29	58	68.5	142	PA1/S	HP DK* ***	£174.96
3/4	25	20	16	158.5	115	34.5	73.5	68.5	142	PA1/S	HP DK* ***	£174.96
1	32	25	16	184	128	39	74	80	155	PA2/S	HP DK* ***	£174.96
1 1/4	40	32	16	207	146	46	97	80	155	PA2/S	HP DK* ***	£174.96
1 1/2	50	40	16	214	164	52	104	102	230	PA3/S	HP DK* ***	£198.29
2	63	50	16	224	199	62	114	102	230	PA3/S	HP DK* ***	£198.29
2 1/2	75	65	16	281	235	87	119	125	304	PA4/S	HP DK* ***	£297.43
3	90	80	16	294	270	105	132	125	304	PA4/S	HP DK* ***	£297.43
4	110	100	16	312	308	129	150	125	304	PA4/S	HP DK* ***	£297.43

VKD Pneumatically Actuated - Fail safe open

G	d	DN	PN*	B	H	B1	B2	E1	H2	ACT	Product Code	List Price (£)
3/8	16	10	16	143	103	29	58	68.5	142	PA1/S	HQ DK* ***	£174.96
1/2	20	15	16	143	103	29	58	68.5	142	PA1/S	HQ DK* ***	£174.96
3/4	25	20	16	158.5	115	34.5	73.5	68.5	142	PA1/S	HQ DK* ***	£174.96
1	32	25	16	184	128	39	74	80	155	PA2/S	HQ DK* ***	£174.96
1 1/4	40	32	16	207	146	46	97	80	155	PA2/S	HQ DK* ***	£174.96
1 1/2	50	40	16	214	164	52	104	102	230	PA3/S	HQ DK* ***	£198.29
2	63	50	16	224	199	62	114	102	230	PA3/S	HQ DK* ***	£198.29
2 1/2	75	65	16	281	235	87	119	125	304	PA4/S	HQ DK* ***	£297.43
3	90	80	16	294	270	105	132	125	304	PA4/S	HQ DK* ***	£297.43
4	110	100	16	312	308	129	150	125	304	PA4/S	HQ DK* ***	£297.43

VKD Pneumatically Actuated - Double acting

G	d	DN	PN*	B	H	B1	B2	E1	H2	ACT	Product Code	List Price (£)
3/8	16	10	16	143	103	29	58	68.5	107	PA1	HR DK* ***	£174.96
1/2	20	15	16	143	103	29	58	68.5	107	PA1	HR DK* ***	£174.96
3/4	25	20	16	158.5	115	34.5	73.5	68.5	107	PA1	HR DK* ***	£174.96
1	32	25	16	158.5	128	39	74	68.5	107	PA1	HR DK* ***	£174.96
1 1/4	40	32	16	207	146	46	97	80	125	PA2	HR DK* ***	£174.96
1 1/2	50	40	16	214	164	52	104	80	125	PA2	HR DK* ***	£174.96
2	63	50	16	224	199	62	114	102	182	PA3	HR DK* ***	£198.29
2 1/2	75	65	16	247	235	87	119	102	182	PA3	HR DK* ***	£204.12
3	90	80	16	294	270	105	132	125	233	PA4	HR DK* ***	£204.12
4	110	100	16	312	308	129	150	125	233	PA4	HR DK* ***	£297.43

* PP PN 10 bar

Actuated valve prices are calculated by adding the above prices to the relevant manual valve prices, see page 64 for example.

VKD DOUBLE UNION BALL VALVES

3/8" -d16 to 2"-d63

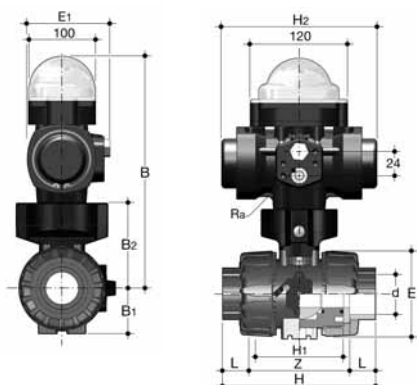

2 1/2" -d75 to 4"-d110

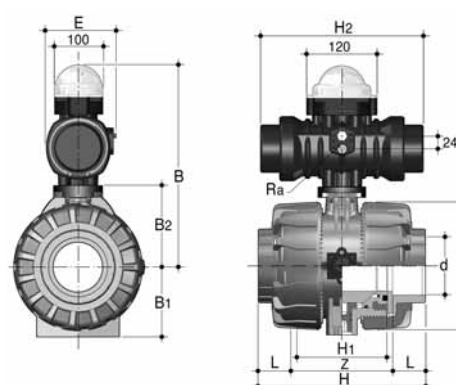

VKD Pneumatically Actuated - Fail safe closed with switch box

G	d	DN	PN*	B	H	B1	B2	E1	H2	ACT	Product Code	List Price (£)
3/8	16	10	16	228	103	29	58	68.5	142	PA1/S	HS DK* ***	£255.96
1/2	20	15	16	228	103	29	58	68.5	142	PA1/S	HS DK* ***	£255.96
3/4	25	20	16	244	115	34.5	73.5	68.5	142	PA1/S	HS DK* ***	£255.96
1	32	25	16	269	128	39	74	80	155	PA2/S	HS DK* ***	£255.96
1 1/4	40	32	16	292	146	46	97	80	155	PA2/S	HS DK* ***	£255.96
1 1/2	50	40	16	299	164	52	104	102	230	PA3/S	HS DK* ***	£279.29
2	63	50	16	309	199	62	114	102	230	PA3/S	HS DK* ***	£279.29
2 1/2	75	65	16	366	235	87	119	125	304	PA4/S	HS DK* ***	£378.43
3	90	80	16	379	270	105	132	125	304	PA4/S	HS DK* ***	£378.43
4	110	100	16	397	308	129	150	125	304	PA4/S	HS DK* ***	£378.43

VKD Pneumatically Actuated - Fail safe open with switch box

G	d	DN	PN*	B	H	B1	B2	E1	H2	ACT	Product Code	List Price (£)
3/8	16	10	16	228	103	29	58	68.5	142	PA1/S	HT DK* ***	£255.96
1/2	20	15	16	228	103	29	58	68.5	142	PA1/S	HT DK* ***	£255.96
3/4	25	20	16	244	115	34.5	73.5	68.5	142	PA1/S	HT DK* ***	£255.96
1	32	25	16	269	128	39	74	80	155	PA2/S	HT DK* ***	£255.96
1 1/4	40	32	16	292	146	46	97	80	155	PA2/S	HT DK* ***	£255.96
1 1/2	50	40	16	299	164	52	104	102	230	PA3/S	HT DK* ***	£279.29
2	63	50	16	309	199	62	114	102	230	PA3/S	HT DK* ***	£279.29
2 1/2	75	65	16	366	235	87	119	125	304	PA4/S	HT DK* ***	£378.43
3	90	80	16	379	270	105	132	125	304	PA4/S	HT DK* ***	£378.43
4	110	100	16	397	308	129	150	125	304	PA4/S	HT DK* ***	£378.43

VKD Pneumatically Actuated - Double acting with switch box

G	d	DN	PN*	B	H	B1	B2	E1	H2	ACT	Product Code	List Price (£)
3/8	16	10	16	228	103	29	58	68.5	107	PA1	HU DK* ***	£255.96
1/2	20	15	16	228	103	29	58	68.5	107	PA1	HU DK* ***	£255.96
3/4	25	20	16	244	115	34.5	73.5	68.5	107	PA1	HU DK* ***	£255.96
1	32	25	16	244	128	39	74	68.5	107	PA1	HU DK* ***	£255.96
1 1/4	40	32	16	292	146	46	97	80	125	PA2	HU DK* ***	£255.96
1 1/2	50	40	16	299	164	52	104	80	125	PA2	HU DK* ***	£255.96
2	63	50	16	309	199	62	114	102	182	PA3	HU DK* ***	£279.29
2 1/2	75	65	16	332	235	87	119	102	182	PA3	HU DK* ***	£285.12
3	90	80	16	379	270	105	132	125	233	PA4	HU DK* ***	£285.12
4	110	100	16	397	308	129	150	125	233	PA4	HU DK* ***	£378.43

* PP PN 10 bar

Actuated valve prices are calculated by adding the above prices to the relevant manual valve prices, see page 64 for example.

TKD 3-WAY BALL VALVES

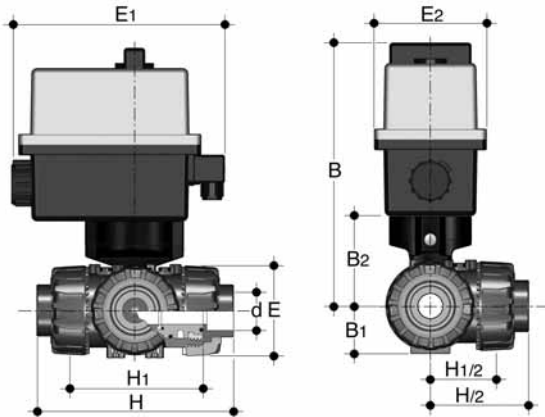

TKD Electric Actuated - Standard

G	d	DN	B	B1	B2	E	E1	E2	H	H1	Product Code	List Price (£)	Product Code	List Price (£)	
												100 to 240 v AC		24 v AC/DC	
3/8	16	10	204.5	29	58	54	187	92	118	80	H1 (T/L)T ****	£320.76	H2 (T/L)T ****	£320.76	
1/2	20	15	204.5	29	58	54	187	92	118	80	H1 (T/L)T ****	£320.76	H2 (T/L)T ****	£320.76	
3/4	25	20	215.5	34.5	69	65	187	92	145	100	H1 (T/L)T ****	£320.76	H2 (T/L)T ****	£320.76	
1	32	25	220.5	39	74	73	187	92	160	110	H1 (T/L)T ****	£320.76	H2 (T/L)T ****	£320.76	
1 1/4	40	32	255.5	46	91	86	187	92	188.5	131	H1 (T/L)T ****	£320.76	H2 (T/L)T ****	£320.76	
1 1/2	50	40	259.5	52	97	98	187	92	219	148	H1 (T/L)T ****	£320.76	H2 (T/L)T ****	£320.76	
2	63	50	279.5	62	114	122	187	92	266.5	179	H1 (T/L)T ****	£320.76	H2 (T/L)T ****	£320.76	

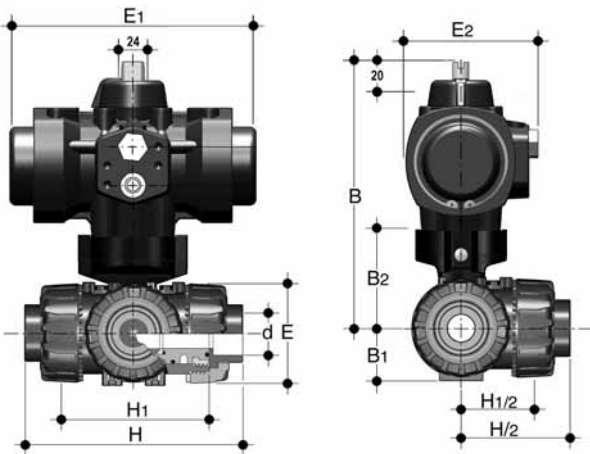

TKD Pneumatic Actuated - Standard

G	d	DN	B	B1	B2	E	E1	E2	H	H1	Product Code	List Price (£)	Product Code	List Price (£)	
												Spring Return		Double Acting	
3/8	16	10	144.5	29	58	54	138	75	118	80	HP (T/L)T ****	£174.96	HR (T/L)T ****	£174.96	
1/2	20	15	160.5	29	58	54	138	75	118	80	HP (T/L)T ****	£174.96	HR (T/L)T ****	£174.96	
3/4	25	20	171.5	34.5	69	65	155.5	86	145	100	HP (T/L)T ****	£174.96	HR (T/L)T ****	£174.96	
1	32	25	176.5	39	74	73	155.5	86	160	110	HP (T/L)T ****	£174.96	HR (T/L)T ****	£174.96	
1 1/4	40	32	195.5	46	91	86	155.5	86	188.5	131	HP (T/L)T ****	£174.96	HR (T/L)T ****	£174.96	
1 1/2	50	40	199.5	52	97	98	155.5	86	219	148	HP (T/L)T ****	£174.96	HR (T/L)T ****	£174.96	
2	63	50	233.5	62	114	122	210	94	266.5	179	HP (T/L)T ****	£174.96	HR (T/L)T ****	£174.96	

Actuated valve prices are calculated by adding the above prices to the relevant manual valve prices, see page 64 for example.

FK BUTTERFLY VALVES

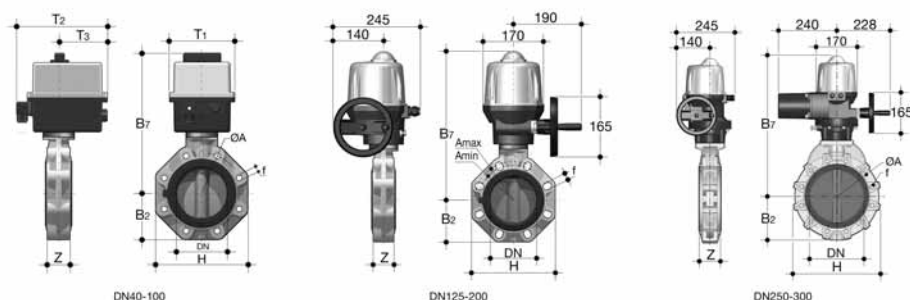

FK Electrically Actuated - Standard

G	d	DN	PN	B7	Z	B2	H	T1	T2	T3	ACT	Product Code	List Price (£)	Product Code	List Price (£)
												100 to 240 v AC		24 v AC/DC	
1½	50	40	16	253	33	60	132	92	189	91	EA2	H1 FK* 106	£320.76	H2 FK* 106	£320.76
2	63	50	16	259	43	70	147	92	189	91	EA2	H1 FK* 107	£320.76	H2 FK* 107	£320.76
2½	75	65	10	266	46	80	165	92	189	91	EA2	H1 FK* 108	£320.76	H2 FK* 108	£320.76
3	90	80	10	308	49	93	185	128	204	96	EA3	H1 FK* 109	£428.76	H2 FK* 109	£428.76
4	110	100	10	322	56	107	211	128	204	96	EA3	H1 FK* 110	£428.76	H2 FK* 110	£428.76
5	140	125	10	425	64	120	240	-	-	-	EA5	H1 FK* 111	£644.76	H2 FK* 111	£644.76
6	160	150	10	438	70	134	268	-	-	-	EA5	H1 FK* 112	£644.76	H2 FK* 112	£644.76
8	225	200	10	435	71	161	323	-	-	-	EA6	H1 FK* 113	£698.76	H2 FK* 113	£698.76
10"	280	250	10	597	114	210	405	-	-	-	EA8	H1 FK* 114	£915.62	H2 FK* 114	£915.62
12	315	300	8	654	114	245	475	-	-	-	EA8	H1 FK* 115	£915.62	H2 FK* 115	£915.62

FK Electrically Actuated - Fail Safe Closed

G	d	DN	PN	B7	Z	B2	H	T1	T2	T3	ACT	Product Code	List Price (£)	Product Code	List Price (£)
												100 to 240 v AC		24 v AC/DC	
1½	50	40	16	253	33	60	132	92	189	91	EB2	H3 FK* 106	£459.00	H4 FK* 106	£459.00
2	63	50	16	259	43	70	147	92	189	91	EB2	H3 FK* 107	£459.00	H4 FK* 107	£459.00
2½	75	65	10	266	46	80	165	92	189	91	EB2	H3 FK* 108	£459.00	H4 FK* 108	£459.00
3	90	80	10	308	49	93	185	128	204	96	EB3	H3 FK* 109	£569.16	H4 FK* 109	£569.16
4	110	100	10	322	56	107	211	128	204	96	EB3	H3 FK* 110	£569.16	H4 FK* 110	£569.16
5	140	125	10	425	64	120	240	-	-	-	EB5	H3 FK* 111	£884.34	H4 FK* 111	£884.34
6	160	150	10	438	70	134	268	-	-	-	EB5	H3 FK* 112	£884.34	H4 FK* 112	£884.34
8	225	200	10	435	71	161	323	-	-	-	EB6	H3 FK* 113	£938.34	H4 FK* 113	£938.34
10	280	250	10	597	114	210	405	-	-	-	EB8	H3 FK* 114	£1,155.20	H4 FK* 114	£1,155.20
12	315	300	8	654	114	245	475	-	-	-	EB8	H3 FK* 115	£1,155.20	H4 FK* 115	£1,155.20

FK Electrically Actuated - Fail Safe Open

G	d	DN	PN	B7	Z	B2	H	T1	T2	T3	ACT	Product Code	List Price (£)	Product Code	List Price (£)
												100 to 240 v AC		24 v AC/DC	
1½	50	40	16	253	33	60	132	92	189	91	EB2	H5 FK* 106	£459.00	H6 FK* 106	£459.00
2	63	50	16	259	43	70	147	92	189	91	EB2	H5 FK* 107	£459.00	H6 FK* 107	£459.00
2½	75	65	10	266	46	80	165	92	189	91	EB2	H5 FK* 108	£459.00	H6 FK* 108	£459.00
3	90	80	10	308	49	93	185	128	204	96	EB3	H5 FK* 109	£569.16	H6 FK* 109	£569.16
4	110	100	10	322	56	107	211	128	204	96	EB3	H5 FK* 110	£569.16	H6 FK* 110	£569.16
5	140	125	10	425	64	120	240	-	-	-	EB5	H5 FK* 111	£884.34	H6 FK* 111	£884.34
6	160	150	10	438	70	134	268	-	-	-	EB5	H5 FK* 112	£884.34	H6 FK* 112	£884.34
8	225	200	10	435	71	161	323	-	-	-	EB6	H5 FK* 113	£938.34	H6 FK* 113	£938.34
10	280	250	10	597	114	210	405	-	-	-	EB8	H5 FK* 114	£1,155.20	H6 FK* 114	£1,155.20
12	315	300	8	654	114	245	475	-	-	-	EB8	H5 FK* 115	£1,155.20	H6 FK* 115	£1,155.20

FK Electrically Actuated - 4 to 20mA Positioning

G	d	DN	PN	B7	Z	B2	H	T1	T2	T3	ACT	Product Code	List Price (£)	Product Code	List Price (£)
												100 to 240 v AC		24 v AC/DC	
1½	50	40	16	253	33	60	132	92	189	91	EM2	H7 FK* 106	£491.40	H8 FK* 106	£491.40
2	63	50	16	259	43	70	147	92	189	91	EM2	H7 FK* 107	£491.40	H8 FK* 107	£491.40
2½	75	65	10	266	46	80	165	92	189	91	EM2	H7 FK* 108	£491.40	H8 FK* 108	£491.40
3	90	80	10	308	49	93	185	128	204	96	EM3	H7 FK* 109	£601.56	H8 FK* 109	£601.56
4	110	100	10	322	56	107	211	128	204	96	EM3	H7 FK* 110	£601.56	H8 FK* 110	£601.56
5	140	125	10	425	64	120	240	-	-	-	EM5	H7 FK* 111	£1066.55	H8 FK* 111	£785.16
6	160	150	10	438	70	134	268	-	-	-	EM5	H7 FK* 112	£1066.55	H8 FK* 112	£785.16
8	225	200	10	435	71	161	323	-	-	-	EM6	H7 FK* 113	£1,120.55	H8 FK* 113	£1,033.56
10	280	250	10	597	114	210	405	-	-	-	EM8	H7 FK* 114	POA	H8 FK* 114	POA
12	315	300	8	654	114	245	475	-	-	-	EM8	H7 FK* 115	POA	H8 FK* 115	POA

Actuated valve prices are calculated by adding the above prices to the relevant manual valve prices, see page 64 for example.

FK BUTTERFLY VALVES

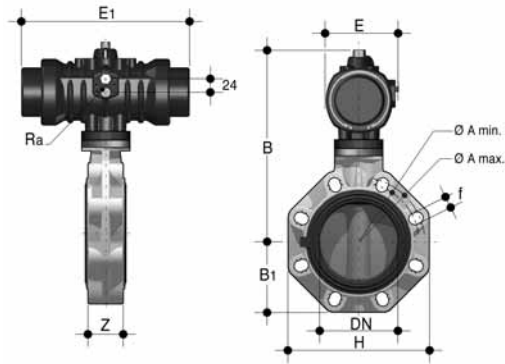

FK Pneumatically Actuated - Fail safe closed

G	d	DN	PN	B	Z	B1	H	E1	E	ACT	Product Code	List Price (£)
1½	50	40	16	234	33	60	132	230	102	PA3/S	HP FK* 106	£198.29
2	63	50	16	240	43	70	147	230	102	PA3/S	HP FK* 107	£198.29
2½	75	65	10	247	46	80	165	230	102	PA3/S	HP FK* 108	£198.29
3	90	80	10	295	49	93	185	304	125	PA4/S	HP FK* 109	£275.40
4	110	100	10	309	56	107	211	304	125	PA4/S	HP FK* 110	£275.40
5	140	125	10	329	64	120	240	479	177	PA6/S	HP FK* 111	£361.80
6	160	150	10	342	70	134	268	479	177	PA6/S	HP FK* 112	£361.80
8	225	200	10	438	71	161	323	479	177	PA6/S	HP FK* 113	£361.80
10	280	250	10	520	114	210	405	598	226	PA7/S	HP FK* 114	£950.40
12	315	300	8	577	114	245	475	598	226	PA7/S	HP FK* 115	£950.40

FK Pneumatically Actuated - Fail safe open

G	d	DN	PN	B	Z	B1	H	E1	E	ACT	Product Code	List Price (£)
1½	50	40	16	234	33	60	132	230	102	PA3/S	HQ FK* 106	£198.29
2	63	50	16	240	43	70	147	230	102	PA3/S	HQ FK* 107	£198.29
2½	75	65	10	247	46	80	165	230	102	PA3/S	HQ FK* 108	£198.29
3	90	80	10	295	49	93	185	304	125	PA4/S	HQ FK* 109	£275.40
4	110	100	10	309	56	107	211	304	125	PA4/S	HQ FK* 110	£275.40
5	140	125	10	329	64	120	240	479	177	PA6/S	HQ FK* 111	£361.80
6	160	150	10	342	70	134	268	479	177	PA6/S	HQ FK* 112	£361.80
8	225	200	10	438	71	161	323	479	177	PA6/S	HQ FK* 113	£361.80
10	280	250	10	520	114	210	405	598	226	PA7/S	HQ FK* 114	£950.40
12	315	300	8	577	114	245	475	598	226	PA7/S	HQ FK* 115	£950.40

FK Pneumatically Actuated - Double acting

G	d	DN	PN	B	Z	B1	H	E1	E	ACT	Product Code	List Price (£)
1½	50	40	16	216	33	60	132	125	80	PA2	HR FK* 106	£198.29
2	63	50	16	222	43	70	147	125	80	PA2	HR FK* 107	£198.29
2½	75	65	10	247	46	80	165	182	102	PA3	HR FK* 108	£198.29
3	90	80	10	261	49	93	185	182	102	PA3	HR FK* 109	£275.40
4	110	100	10	275	56	107	211	182	102	PA3	HR FK* 110	£275.40
5	140	125	10	295	64	120	240	182	102	PA3	HR FK* 111	£275.40
6	160	150	10	342	70	134	268	233	125	PA4	HR FK* 112	£275.40
8	225	200	10	418	71	161	323	276	152	PA5	HR FK* 113	£307.80
10	280	250	10	520	114	210	405	444	226	PA7	HR FK* 114	£734.40
12	315	300	8	577	114	245	475	444	226	PA7	HR FK* 115	£734.40

Actuated valve prices are calculated by adding the above prices to the relevant manual valve prices, see page 64 for example.

FK BUTTERFLY VALVES

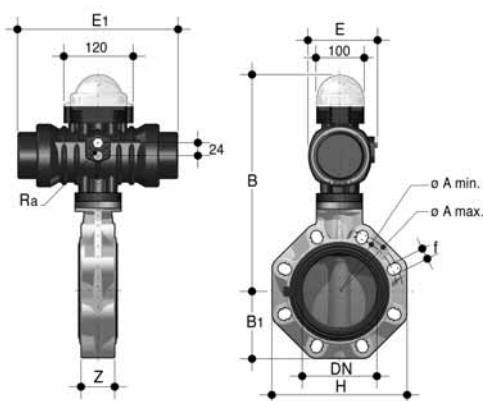

FK Pneumatically Actuated - Fail safe closed

G	d	DN	PN	B	Z	B ₁	H	E ₁	E	ACT	Product Code	List Price (£)
1 ^{1/2}	50	40	16	319	33	60	132	230	102	PA3/S	HS FK* 106	£279.29
2	63	50	16	325	43	70	147	230	102	PA3/S	HS FK* 107	£279.29
2 ^{1/2}	75	65	10	332	46	80	165	230	102	PA3/S	HS FK* 108	£279.29
3	90	80	10	380	49	93	185	304	125	PA4/S	HS FK* 109	£356.40
4	110	100	10	394	56	107	211	304	125	PA4/S	HS FK* 110	£356.40
5	140	125	10	414	64	120	240	479	177	PA6/S	HS FK* 111	£442.80
6	160	150	10	427	70	134	268	479	177	PA6/S	HS FK* 112	£442.80
8	225	200	10	523	71	161	323	479	177	PA6/S	HS FK* 113	£442.80
10	280	250	10	605	114	210	405	598	226	PA7/S	HS FK* 114	£1,013.40
12	315	300	8	662	114	245	475	598	226	PA7/S	HS FK* 115	£1,013.40

FK Pneumatically Actuated - Fail safe open

G	d	DN	PN	B	Z	B ₁	H	E ₁	E	ACT	Product Code	List Price (£)
1 ^{1/2}	50	40	16	319	33	60	132	230	102	PA3/S	HT FK* 106	£279.29
2	63	50	16	325	43	70	147	230	102	PA3/S	HT FK* 107	£279.29
2 ^{1/2}	75	65	10	332	46	80	165	230	102	PA3/S	HT FK* 108	£279.29
3	90	80	10	380	49	93	185	304	125	PA4/S	HT FK* 109	£356.40
4	110	100	10	394	56	107	211	304	125	PA4/S	HT FK* 110	£356.40
5	140	125	10	414	64	120	240	479	177	PA6/S	HT FK* 111	£442.80
6	160	150	10	427	70	134	268	479	177	PA6/S	HT FK* 112	£442.80
8	225	200	10	523	71	161	323	479	177	PA6/S	HT FK* 113	£442.80
10	280	250	10	605	114	210	405	598	226	PA7/S	HT FK* 114	£1,013.40
12	315	300	8	662	114	245	475	598	226	PA7/S	HT FK* 115	£1,013.40

FK Pneumatically Actuated - Double acting

G	d	DN	PN	B	Z	B ₁	H	E ₁	E	ACT	Product Code	List Price (£)
1 ^{1/2}	50	40	16	301	33	60	132	125	80	PA2	HU FK* 115	£279.29
2	63	50	16	307	43	70	147	125	80	PA2	HU FK* 116	£279.29
2 ^{1/2}	75	65	10	332	46	80	165	182	102	PA3	HU FK* 117	£279.29
3	90	80	10	346	49	93	185	182	102	PA3	HU FK* 118	£356.40
4	110	100	10	360	56	107	211	182	102	PA3	HU FK* 119	£356.40
5	140	125	10	380	64	120	240	182	102	PA3	HU FK* 120	£356.40
6	160	150	10	427	70	134	268	233	125	PA4	HU FK* 121	£356.40
8	225	200	10	503	71	161	323	276	152	PA5	HU FK* 122	£388.80
10	280	250	10	605	114	210	405	444	226	PA7	HU FK* 123	£815.40
12	315	300	8	662	114	245	475	444	226	PA7	HU FK* 124	£815.40

Actuated valve prices are calculated by adding the above prices to the relevant manual valve prices, see page 64 for example.

VM DIAPHRAGM VALVES

VM Pneumatic actuated - FSC

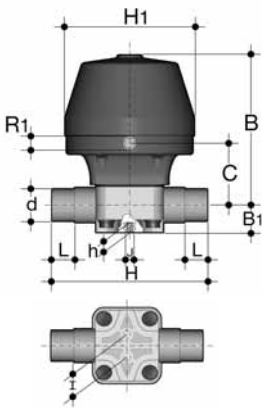

d	DN	PN	B	B ₁	C	H	h	H ₁	I	J	L	R ₁	g	Product Code	List Price (£)
Fail Safe Closed															
1/2 / 20	15	10	175	26	66	124	12	126	25	M6	16	1/4	1850	HP (V/U) M * * * *	£141.13
3/4 / 25	20	10	175	26	66	144	12	126	25	M6	19	1/4	1850	HP (V/U) M * * * *	£141.13
1 / 32	25	10	175	26	66	154	12	126	25	M6	23	1/4	1850	HP (V/U) M * * * *	£141.13
1 1/4 / 40	32	10	244	40	103	174	18	155	44.5	M8	27	1/4	4000	HP (V/U) M * * * *	£192.46
1 / 50	40	10	244	40	103	194	18	155	44.5	M8	32	1/4	4000	HP (V/U) M * * * *	£192.46
2 / 63	50	10	292	40	125	224	18	210	44.5	M8	39	1/4	6950	HP (V/U) M * * * *	£243.78
2 1/2 / 75	65	6	325	55	187	284	23	258	100	M12	51	1/4	15000	HP (V/U) M * * * *	£352.84
3 / 90	80	6	325	55	187	300	23	258	100	M12	51	1/4	15500	HP (V/U) M * * * *	£513.22
4 / 110	100	6	355	69	268	350	23	258	120	M12	-	1/4	25500	HP (V/U) M * * * *	£468.31

VM Pneumatic actuated - FSO/DA

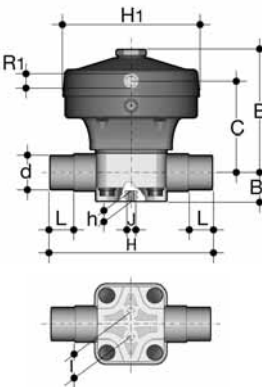

d	DN	PN	B	B ₁	C	H	h	H ₁	I	J	L	R ₁	g	Product Code	List Price (£)	Product Code	List Price (£)
Fail Safe Open Double Acting																	
1/2 / 20	15	10	144	26	120	124	12	126	25	M6	16	1/4	1300	HQ (V/U) M * * * *	£57.74	HR (V/U) M * * * *	£57.74
3/4 / 25	20	10	144	26	120	144	12	126	25	M6	19	1/4	1300	HQ (V/U) M * * * *	£57.74	HR (V/U) M * * * *	£57.74
1 / 32	25	10	144	26	120	154	12	126	25	M6	23	1/4	1300	HQ (V/U) M * * * *	£57.74	HR (V/U) M * * * *	£57.74
1 1/4 / 40	32	10	201	40	133	174	18	155	44.5	M8	27	1/4	2800	HQ (V/U) M * * * *	£83.40	HR (V/U) M * * * *	£83.40
1 / 50	40	10	201	40	133	194	18	155	44.5	M8	32	1/4	2800	HQ (V/U) M * * * *	£83.40	HR (V/U) M * * * *	£83.40
2 / 63	50	10	237	40	156	224	18	210	44.5	M8	39	1/4	4600	HQ (V/U) M * * * *	£83.40	HR (V/U) M * * * *	£83.40
2 1/2 / 75	65	6	305	55	252	285	23	258	100	M12	44	1/4	12500	HQ (V/U) M * * * *	£83.40	HR (V/U) M * * * *	£83.40
3 / 90	80	6	305	55	252	300	23	258	100	M12	51	1/4	13000	HQ (V/U) M * * * *	£96.23	HR (V/U) M * * * *	£96.23
4 / 110	100	6	330	69	268	350	23	258	120	M12	-	1/4	22000	HQ (V/U) M * * * *	£96.23	HR (V/U) M * * * *	£96.23

VM Pneumatic actuated with limit switches - FSC

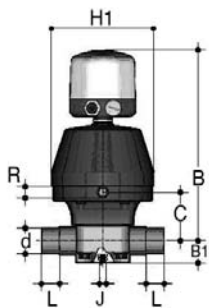

d	DN	PN	B	B ₁	C	H	h	H ₁	I	J	L	R ₁	g	Product Code	List Price (£)
Fail Safe Closed															
1/2 / 20	15	10	275	26	66	124	12	126	25	M6	16	1/4	1850	HS (V/U) M * * * *	£224.53
3/4 / 25	20	10	275	26	66	144	12	126	25	M6	19	1/4	1850	HS (V/U) M * * * *	£224.53
1 / 32	25	10	275	26	66	154	12	126	25	M6	23	1/4	1850	HS (V/U) M * * * *	£224.53
1 1/4 / 40	32	10	344	40	103	174	18	155	44.5	M8	27	1/4	4000	HS (V/U) M * * * *	£275.85
1 / 50	40	10	344	40	103	194	18	155	44.5	M8	32	1/4	4000	HS (V/U) M * * * *	£275.85
2 / 63	50	10	392	40	125	224	18	210	44.5	M8	39	1/4	6950	HS (V/U) M * * * *	£327.18
2 1/2 / 75	65	6	425	55	187	284	23	258	100	M12	51	1/4	15000	HS (V/U) M * * * *	£436.23
3 / 90	80	6	425	55	187	300	23	258	100	M12	51	1/4	15500	HS (V/U) M * * * *	£596.61
4 / 110	100	6	455	69	268	350	23	258	120	M12	-	1/4	25500	HS (V/U) M * * * *	£551.71

VM Pneumatic actuated with limit switches - FSO/DA

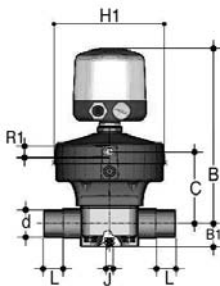

d	DN	PN	B	B ₁	C	H	h	H ₁	I	J	L	R ₁	g	Product Code	List Price (£)	Product Code	List Price (£)
Fail Safe Open Double Acting																	
1/2 / 20	15	10	244	26	120	124	12	126	25	M6	16	1/4	1300	HT (V/U) M * * * *	£141.13	HU (V/U) M * * * *	£141.13
3/4 / 25	20	10	244	26	120	144	12	126	25	M6	19	1/4	1300	HT (V/U) M * * * *	£141.13	HU (V/U) M * * * *	£141.13
1 / 32	25	10	244	26	120	154	12	126	25	M6	23	1/4	1300	HT (V/U) M * * * *	£141.13	HU (V/U) M * * * *	£141.13
1 1/4 / 40	32	10	301	40	133	174	18	155	44.5	M8	27	1/4	2800	HT (V/U) M * * * *	£166.80	HU (V/U) M * * * *	£166.80
1 / 50	40	10	301	40	133	194	18	155	44.5	M8	32	1/4	2800	HT (V/U) M * * * *	£166.80	HU (V/U) M * * * *	£166.80
2 / 63	50	10	337	40	156	224	18	210	44.5	M8	39	1/4	4600	HT (V/U) M * * * *	£166.80	HU (V/U) M * * * *	£166.80
2 1/2 / 75	65	6	405	55	252	285	23	258	100	M12	44	1/4	12500	HT (V/U) M * * * *	£166.80	HU (V/U) M * * * *	£166.80
3 / 90	80	6	405	55	252	300	23	258	100	M12	51	1/4	13000	HT (V/U) M * * * *	£179.63	HU (V/U) M * * * *	£179.63
4 / 110	100	6	430	69	268	350	23	258	120	M12	-	1/4	22000	HT (V/U) M * * * *	£179.63	HU (V/U) M * * * *	£179.63

Actuated valve prices are calculated by adding the above prices to the relevant manual valve prices, see page 64 for example.

CM DIAPHRAGM VALVES

PVC-U with Metric series plain female ends

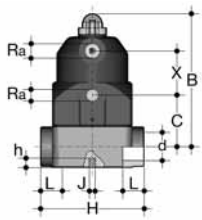

d	DN	PN	B	C	X	RA	L	H	h	J	g	Product Code	List Price (£)	Product Code	List Price (£)	Product Code	List Price (£)
16	12	6	98	38	34	1/8"	14	75	8	M5	340	H* CME 305	£67.41	H* CMF 305	£79.21	H* CMG 305	£85.67
20	15	6	98	38	34	1/8"	16	75	8	M5	340	H* CME 306	£71.47	H* CMF 306	£79.07	H* CMG 306	£86.49

HP = Fail safe closed
 HQ = Fail safe open
 HR = double acting

PVC-U with BSP parallel threaded female ends

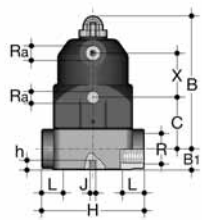

R	DN	PN	B	C	X	RA	L	H	h	J	g	Product Code	List Price (£)	Product Code	List Price (£)	Product Code	List Price (£)
3/8"	12	6	98	38	34	1/8"	14	75	8	M5	340	H* CME B01	£67.41	H* CMF B01	£79.21	H* CMG B01	£85.67
1/2"	15	6	98	38	34	1/8"	16	75	8	M5	340	H* CME B02	£71.46	H* CMF B02	£86.69	H* CMG B02	£87.26

HP = Fail safe closed
 HQ = Fail safe open
 HR = double acting

PVC-U with unionised BS series plain female ends

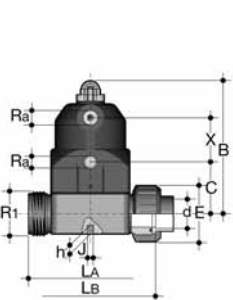

d	DN	PN	B	C	X	R1	X	RA	LA	LB	h	J	g	Product Code	List Price (£)	Product Code	List Price (£)	Product Code	List Price (£)
1/2"	15	6	98	38	41	1"	34	1/8"	90	96	8	M5	340	H* CUE 102	£92.25	H* CUF102	£100.90	H* CUG 102	£109.69

PVC-U with unionised Metric series plain female ends

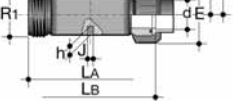

d	DN	PN	B	C	X	R1	X	RA	LA	LB	h	J	g	Product Code	List Price (£)	Product Code	List Price (£)	Product Code	List Price (£)
20	15	6	98	38	41	1"	34	1/8"	90	96	8	M5	340	H* CUE 306	£92.25	H* CUF 306	£100.90	H* CUG 306	£109.69

HP = Fail safe closed
 HQ = Fail safe open
 HR = double acting

PVC-U with unionised BSP parallel threaded female ends

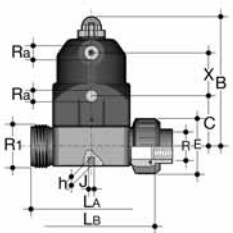

R	DN	PN	B	C	X	R1	X	RA	LA	LB	h	J	g	Product Code	List Price (£)	Product Code	List Price (£)	Product Code	List Price (£)
1/2"	15	6	98	38	41	1"	34	1/8"	90	96	8	M5	340	H* CUE B02	£94.94	H* CUFB02	£103.59	H* CUG B02	£112.38

HP = Fail safe closed
 HQ = Fail safe open
 HR = double acting

PVC-U with Metric series plain male ends

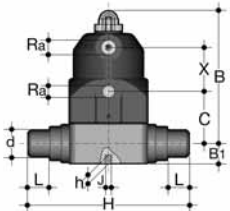

d	DN	PN	B	C	X	RA	L	H	h	J	g	Product Code	List Price (£)	Product Code	List Price (£)	Product Code	List Price (£)
20	15	6	98	38	34	1/8"	16	124	8	M5	340	H* CME 406	£71.47	H* CMF 406	£81.47	H* CMG 406	£90.06

HP = Fail safe closed
 HQ = Fail safe open
 HR = double acting

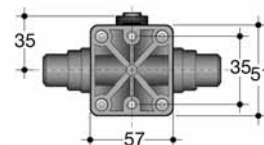
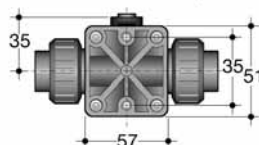
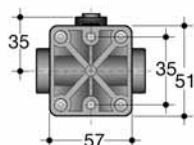

Prices for other materials are available on request.

VV ANGLE SEAT VALVES

PVC-U VV Pneumatic Fail Safe Closed

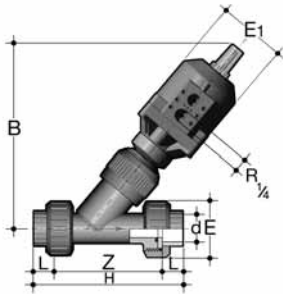

d	DN	PN	B	E	E	H	Z	L	g	Product Code	List Price (£)	d	Product Code	List Price (£)
										Solvent Cement Socket - IMPERIAL		Solvent Cement Socket - METRIC		
1/2	20	10	200	80	55	135	103	16	975	HP VUE 102	£190.53	20	HP VUE 306	£190.53
3/4	25	10	209	80	66	158	120	19	1110	HP VUE 103	£205.29	25	HP VUE 307	£205.29
1	32	10	220	80	75	176	132	22	1305	HP VUE 104	£208.49	32	HP VUE 308	£208.49
1 1/4	40	10	230	80	87	207	155	26	1660	HP VUE 105	£208.49	40	HP VUE 309	£208.49
1 1/2	50	10	240	80	100	243	181	31	1990	HP VUE 106	£243.78	50	HP VUE 310	£243.78
2	63	10	254	80	120	298	222	38	2830	HP VUE 107	£280.99	63	HP VUE 311	£280.99

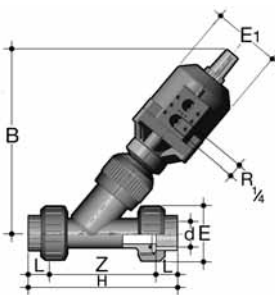

d	DN	PN	B	E	E	H	Z	L	g	Product Code	List Price (£)
										Threaded Socket - BSP	
1/2	20	10	200	80	55	135	103	16	975	HP VUE B02	£193.74
3/4	25	10	209	80	66	158	120	19	1110	HP VUE B03	£209.14
1	32	10	220	80	75	176	132	22	1305	HP VUE B04	£214.27
1 1/4	40	10	230	80	87	207	155	26	1660	HP VUE B05	£216.19
1 1/2	50	10	240	80	100	243	181	31	1990	HP VUE B06	£255.32
2	63	10	254	80	120	298	222	38	2830	HP VUE B07	£296.38

PVC-U VV Pneumatic Fail Safe Open

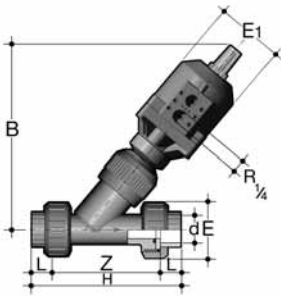

d	DN	PN	B	E	E	H	Z	L	g	Product Code	List Price (£)	d	Product Code	List Price (£)
										Solvent Cement Socket - IMPERIAL		Solvent Cement Socket - METRIC		
1/2	20	10	200	80	55	135	103	16	975	HQ VUE 102	£190.53	20	HQ VUE 306	£190.53
3/4	25	10	209	80	66	158	120	19	1110	HQ VUE 103	£205.29	25	HQ VUE 307	£205.29
1	32	10	220	80	75	176	132	22	1305	HQ VUE 104	£208.49	32	HQ VUE 308	£208.49
1 1/4	40	10	230	80	87	207	155	26	1660	HQ VUE 105	£208.49	40	HQ VUE 309	£208.49
1 1/2	50	10	240	80	100	243	181	31	1990	HQ VUE 106	£243.78	50	HQ VUE 310	£243.78
2	63	10	254	80	120	298	222	38	2830	HQ VUE 107	£280.99	63	HQ VUE 311	£280.99

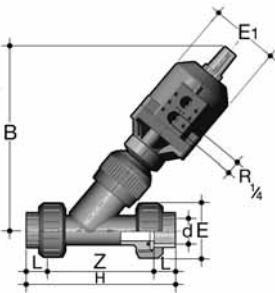

d	DN	PN	B	E	E	H	Z	L	g	Product Code	List Price (£)
										Threaded Socket - BSP	
1/2	20	10	200	80	55	135	103	16	975	HQ VUE B02	£193.74
3/4	25	10	209	80	66	158	120	19	1110	HQ VUE B03	£209.14
1	32	10	220	80	75	176	132	22	1305	HQ VUE B04	£214.27
1 1/4	40	10	230	80	87	207	155	26	1660	HQ VUE B05	£216.19
1 1/2	50	10	240	80	100	243	181	31	1990	HQ VUE B06	£255.32
2	63	10	254	80	120	298	222	38	2830	HQ VUE B07	£296.38

VV ANGLE SEAT VALVES

PVC-U VV Pneumatic Double Acting

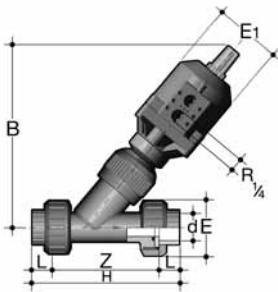

d	DN	PN	B	E	E	H	Z	L	g	Product Code	List Price (£)	d	Product Code	List Price (£)	
											Solvent Cement Socket - IMPERIAL		Solvent Cement Socket - METRIC		
1/2	20	10	200	80	55	135	103	16	975	HR VUE 102	£190.53	20	HR VUE 306	£190.53	
3/4	25	10	209	80	66	158	120	19	1110	HR VUE 103	£205.29	25	HR VUE 307	£205.29	
1	32	10	220	80	75	176	132	22	1305	HR VUE 104	£208.49	32	HR VUE 308	£208.49	
1 1/4	40	10	230	80	87	207	155	26	1660	HR VUE 105	£208.49	40	HR VUE 309	£208.49	
1 1/2	50	10	240	80	100	243	181	31	1990	HR VUE 106	£243.78	50	HR VUE 310	£243.78	
2	63	10	254	80	120	298	222	38	2830	HR VUE 107	£280.99	63	HR VUE 311	£280.99	

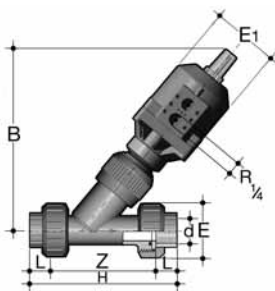

d	DN	PN	B	E	E	H	Z	L	g	Product Code	List Price (£)	
											Threaded Socket - BSP	
1/2	20	10	200	80	55	135	103	16	975	HR VUE B02	£193.74	
3/4	25	10	209	80	66	158	120	19	1110	HR VUE B03	£209.14	
1	32	10	220	80	75	176	132	22	1305	HR VUE B04	£214.27	
1 1/4	40	10	230	80	87	207	155	26	1660	HR VUE B05	£216.19	
1 1/2	50	10	240	80	100	243	181	31	1990	HR VUE B06	£255.32	
2	63	10	254	80	120	298	222	38	2830	HR VUE B07	£296.38	

SOLENOID VALVE PRODUCT CODE SELECTOR

Body Size	Seal Material/Operation	Valve Bore	Voltage	Size Ends
1 = Small Body - 2-Way 2 = Large Body - 2-Way 3 = Small Body - 3-Way 4 = Large Body - 3-Way	A = EPDM / Fail Safe Closed B = FPM / Fail Safe Closed D = EPDM / Fail Safe Open E = FPM / Fail Safe Open F = EPDM / Mixer G = FPM / Mixer H = EPDM / Diverter I = FPM / Diverter	04 = 4mm 06 = 6mm 08 = 8mm 10 = 10mm 15 = 15mm	A = 240v AC B = 110v AC C = 24v AC D = 110v DC E = 24v DC F = 12v DC	00 = 1/4" 01 = 3/8" 02 = 1/2" B0 = 1/4" BSP B1 = 3/8" BSP B2 = 1/2" BSP 03 = 10mm 04 = 12mm 05 = 16mm 06 = 20mm

2-WAY SOLENOID VALVES

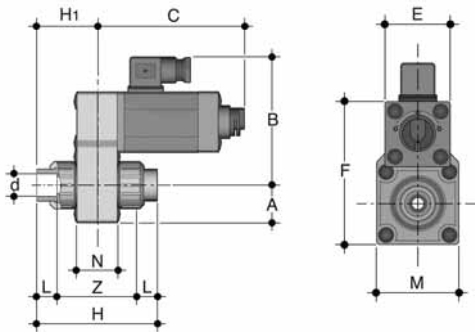

Solvent Cement Socket - Imperial

Body Size	Bore Size (DN) mm	Line Pressure Max (bar)	End Connection	KV	A	B	C	E	F	M	N	L	Z	H	H ₁	g	List Price (£)	List Price (£)
																	EPDM	FPM
Small	4	6	1/4"	6.5	22.5	105	89	39	87	50	30	12	60	84	42	430	£142.78	£157.19
Small	6	4	1/4"	11.0	22.5	105	89	39	87	50	30	12	60	84	42	430	£142.78	£157.19
Small	4	6	3/8"	6.5	22.5	105	89	39	87	50	30	14	60	88	44	430	£142.78	£157.19
Small	6	4	3/8"	11.0	22.5	105	89	39	87	50	30	14	60	88	44	430	£142.78	£157.19
Small	8	2	3/8"	13.5	22.5	105	89	39	87	50	30	14	60	88	44	430	£142.78	£157.19
Large	8	6	3/8"	18.3	32.5	121.5	109	52	113	65	35	14	71	99	49.5	1060	£211.97	£221.99
Large	10	4	3/8"	33.3	32.5	121.5	109	52	113	65	35	14	71	99	49.5	1060	£211.97	£221.99
Large	10	4	1/2"	33.3	32.5	121.5	109	52	113	65	35	16.5	71	104	52	1060	£211.97	£221.99
Large	15	2	1/2"	58.3	32.5	121.5	109	52	113	65	35	16.5	71	104	52	1060	£211.97	£221.99

Solvent Cement Socket - Metric

Body Size	Bore Size (DN) mm	Line Pressure Max (bar)	End Connection	KV	A	B	C	E	F	M	N	L	Z	H	H ₁	g	List Price (£)	List Price (£)
																	EPDM	FPM
Small	4	6	10mm	6.5	22.5	105	89	39	87	50	30	12	60	84	42	430	£142.78	£157.19
Small	6	4	12mm	11.0	22.5	105	89	39	87	50	30	12	60	84	42	430	£142.78	£157.19
Small	4	6	16mm	6.5	22.5	105	89	39	87	50	30	14	60	88	44	430	£142.78	£157.19
Small	6	4	16mm	11.0	22.5	105	89	39	87	50	30	14	60	88	44	430	£142.78	£157.19
Small	8	2	16mm	13.5	22.5	105	89	39	87	50	30	14	60	88	44	430	£142.78	£157.19
Large	8	6	16mm	18.3	32.5	121.5	109	52	113	65	35	14	71	99	49.5	1060	£211.97	£221.99
Large	10	4	16mm	33.3	32.5	121.5	109	52	113	65	35	14	71	99	49.5	1060	£211.97	£221.99
Large	10	4	20mm	33.3	32.5	121.5	109	52	113	65	35	16	71	103	51.5	1060	£211.97	£221.99
Large	15	2	20mm	58.3	32.5	121.5	109	52	113	65	35	16	71	103	51.5	1060	£211.97	£221.99

Threaded Socket - BSP

Body Size	Bore Size (DN) mm	Line Pressure Max (bar)	End Connection	KV	A	B	C	E	F	M	N	L	Z	H	H ₁	g	List Price (£)	List Price (£)
																	EPDM	FPM
Small	4	6	1/4"	6.5	22.5	105	89	39	87	50	30	11	63	85	42.5	430	£142.78	£157.19
Small	6	4	1/4"	11.0	22.5	105	89	39	87	50	30	11	63	85	42.5	430	£142.78	£157.19
Small	4	6	3/8"	6.5	22.5	105	89	39	87	50	30	11.4	63	85.8	42.9	430	£142.78	£157.19
Small	6	4	3/8"	11.0	22.5	105	89	39	87	50	30	11.4	63	85.8	42.9	430	£142.78	£157.19
Small	8	2	3/8"	13.5	22.5	105	89	39	87	50	30	11.4	63	85.8	42.9	430	£142.78	£157.19
Large	8	6	3/8"	18.3	32.5	121.5	109	52	113	65	35	11.4	74	96.8	48.4	1060	£211.97	£221.99
Large	10	4	3/8"	33.3	32.5	121.5	109	52	113	65	35	11.4	74	96.8	48.4	1060	£211.97	£221.99
Large	10	4	1/2"	33.3	32.5	121.5	109	52	113	65	35	15	75	105	52.5	1060	£211.97	£221.99
Large	15	2	1/2"	58.3	32.5	121.5	109	52	113	65	35	15	75	105	52.5	1060	£211.97	£221.99

3-WAY SOLENOID VALVES

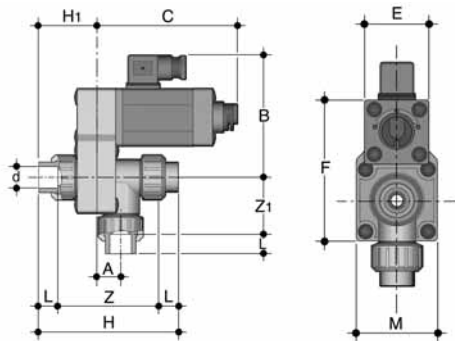

Solvent Cement Socket - Imperial

Body Size	Bore Size (DN) mm	Line Pressure Max (bar)	End Connection	KV	A	B	C	E	F	M	N	L	Z	H	H1	g	List Price (£)	List Price (£)
																	EPDM	FPM
Small	4	4	1/4"	6.8	14	105	89	39	87	50	12	69	36	93	42	455	£214.87	£221.99
Small	6	2.5	1/4"	11.6	14	105	89	39	87	50	12	69	36	93	42	455	£214.87	£221.99
Small	4	4	3/8"	6.8	14	105	89	39	87	50	14	69	36	97	44	455	£214.87	£221.99
Small	6	2.5	3/8"	11.6	14	105	89	39	87	50	14	69	36	97	44	455	£214.87	£221.99
Small	8	1.5	3/8"	13.8	14	105	89	39	87	50	14	69	36	97	44	455	£214.87	£221.99
Large	8	6	3/8"	20.0	22	121.5	109	52	113	65	14	89.5	46.5	117.5	49.5	1060	£295.16	£314.38
Large	10	4	3/8"	32.5	22	121.5	109	52	113	65	14	89.5	46.5	117.5	49.5	1060	£295.16	£314.38
Large	8	6	1/2"	20.0	22	121.5	109	52	113	65	16.5	89.5	46.5	122.5	52	1060	£295.16	£314.38
Large	10	4	1/2"	32.5	22	121.5	109	52	113	65	16.5	89.5	46.5	122.5	53	1060	£295.16	£314.38
Large	15	2	1/2"	60.3	22	121.5	109	52	113	65	16.5	89.5	46.5	122.5	54	1060	£295.16	£314.38

Solvent Cement Socket - Metric

Body Size	Bore Size (DN) mm	Line Pressure Max (bar)	End Connection	KV	A	B	C	E	F	M	N	L	Z	H	H1	g	List Price (£)	List Price (£)
																	EPDM	FPM
Small	4	4	10mm	6.8	14	105	89	39	87	50	12	69	36	93	42	455	£214.87	£221.99
Small	6	2.5	10mm	11.6	14	105	89	39	87	50	12	69	36	93	42	455	£214.87	£221.99
Small	8	1.5	12mm	13.8	14	105	89	39	87	50	14	69	36	93	42	455	£214.87	£221.99
Small	4	4	16mm	6.8	14	105	89	39	87	50	14	69	36	97	44	455	£214.87	£221.99
Small	6	2.5	16mm	11.6	14	105	89	39	87	50	14	69	36	97	44	455	£214.87	£221.99
Small	8	1.5	16mm	13.8	14	105	89	39	87	50	14	69	36	97	44	455	£214.87	£221.99
Large	8	6	16mm	20.0	22	121.5	109	52	113	65	14	89.5	46.5	117.5	49.5	1060	£295.16	£314.38
Large	10	4	16mm	32.5	22	121.5	109	52	113	65	14	89.5	46.5	117.6	49.6	1060	£295.16	£314.38
Large	8	6	20mm	20.0	22	121.5	109	52	113	65	16	89.5	46.5	121.5	51.5	1060	£295.16	£314.38
Large	10	4	20mm	32.5	22	121.5	109	52	113	65	16	89.5	46.5	121.6	51.5	1060	£295.16	£314.38
Large	15	2	20mm	60.3	22	121.5	109	52	113	65	16	89.5	46.5	121.7	51.5	1060	£295.16	£314.38

Threaded Socket - BSP

Body Size	Bore Size (DN) mm	Line Pressure Max (bar)	End Connection	KV	A	B	C	E	F	M	N	L	Z	H	H1	g	List Price (£)	List Price (£)
																	EPDM	FPM
Small	4	4	1/4"	6.8	14	105	89	39	87	50	11	72	37.5	94	42.5	455	£214.87	£221.99
Small	6	2.5	1/4"	11.6	14	105	89	39	87	50	11	72	37.5	94	42.5	455	£214.87	£221.99
Small	4	4	3/8"	6.8	14	105	89	39	87	50	11.4	72	37.5	94.8	42.9	455	£214.87	£221.99
Small	6	2.5	3/8"	11.6	14	105	89	39	87	50	11.4	72	37.5	94.8	42.9	455	£214.87	£221.99
Small	8	1.5	3/8"	13.8	14	105	89	39	87	50	11.4	72	37.5	94.8	42.9	455	£214.87	£221.99
Large	8	6	3/8"	20.0	22	121.5	109	52	113	65	11.4	92.5	48	115.3	48.4	1060	£295.16	£314.38
Large	10	4	3/8"	32.5	22	121.5	109	52	113	65	11.4	92.5	48	115.3	48.4	1060	£295.16	£314.38
Large	8	6	1/2"	20.0	22	121.5	109	52	113	65	15	93.5	48.5	123.5	52.5	1060	£295.16	£314.38
Large	10	4	1/2"	32.5	22	121.5	109	52	113	65	15	93.5	48.5	123.5	52.5	1060	£295.16	£314.38
Large	15	2	1/2"	60.3	22	121.5	109	52	113	65	15	93.5	48.5	123.5	52.5	1060	£295.16	£314.38

VKD & TKD DUAL BLOCK ACCESSORIES

PowerQuick CP

Actuation kit for VKD & TKD



d	ISO	Square	Product Code	List Price (£)
3/8"/16	F03-04*	11	KT PQC PEF	£30.08
1/2"/20	F03-04*	11	KT PQC PEF	£30.08
3/4"/25	F03-05*	11	KT PQC PGG	£31.90
3/4"/25	F04	11	KT PQC PG4	£31.90
1"/32	F03-05*	11	KT PQC PHH	£31.90
1"/32	F04	11	KT PQC PH4	£31.90
1 1/4"/40	F05-07*	14	KT PQC PI I	£36.46
1 1/2"/50	F05-07*	14	KT PQC PJJ	£36.46
2"/63	F05-07*	14	KT PQC PLL	£38.74

* For limit switch box MSKD type

MSKD - Limit Switch Box

Limit switch box MS type for manual valve, to be installed with Actuation Kit for VKD & TKD



d	ISO	Square	Product Code	List Price (£)
Electromechanical				
3/8"/16 - 1"/32	F03-05	11	KT MSK D1	£94.40
1 1/4"/40 - 2"/63	F03-05	14	KT MSK D2	£94.40
Inductive 2 wires				
3/8"/16 - 1"/32	F03-05	11	KT MSK D1I	£351.63
1 1/4"/40 - 2"/63	F03-05	14	KT MSK D2I	£351.63
Inductive Namur				
3/8"/16 - 1"/32	F03-05	11	KT MSK D1N	£382.35
1 1/4"/40 - 2"/63	F03-05	14	KT MSK D2N	£382.35

SKD - Stem Extension Kit

Extension Kit for VKD & TKD (Pipe not included)



d	Product Code	List Price (£)
3/8"/16 (d25 pipe required)	KT SKD EF	£29.19
1/2"/20 (d25 pipe required)	KT SKD EF	£29.19
3/4"/25 (d25 pipe required)	KT SKD GG	£29.82
1"/32 (d25 pipe required)	KT SKD HH	£30.61
1 1/4"/40 (d32 pipe required)	KT SKD II	£30.92
1 1/2"/50 (d32 pipe required)	KT SKD JJ	£32.18
2"/63 (d32 pipe required)	KT SKD LL	£35.50

LTKD (90° - 180°) - Rotational stoke limiter 90° or 180° for use with TKD



90°

d	Product Code	List Price (£)
16-20	LTKD 9020	£14.64
25-32	LTKD 9032	£16.40
40-50	LTKD 9050	£19.60
63	LTKD 9063	£23.40

180°

d	Product Code	List Price (£)
16-20	LTKD 8020	£14.64
25-32	LTKD 8032	£16.40
40-50	LTKD 8050	£19.60
63	LTKD 8063	£23.40

SHKD - Handle Block Kit

Handle block kit to be installed on the handle of the VKD & TKD valve (handle not included)



d	Product Code	List Price (£)
3/8"/16	KT SHKD EF	£13.41
1/2"/20	KT SHKD EF	£13.41
3/4"/25	KT SHKD GH	£14.99
1"/32	KT SHKD GH	£14.99
1 1/4"/40	KT SHKD IJ	£17.35
1 1/2"/50	KT SHKD IJ	£17.35
2"/63	KT SHKD LL	£18.62

PMKD - Distance Plate

Distance plate for wall mounting installations



d	Product Code	List Price (£)
3/8"/16 - 1"/32	PM KD 01	£7.10
1 1/4"/40 - 2"/63	PM KD 02	£7.73

Distance Plate Kit

Kit compressed by distant plate PMKD, screws, brass inserts for wall mounting installations



d	Product Code	List Price (£)
3/8"/16 - 1"/32	KT PMKD 01	£8.83
1 1/4"/40 - 2"/63	KT PMKD 02	£9.31

Fastening Stainless Steel Inserts

Stainless steel threaded inserts to be installed under the valve for bracketing and support (20 pieces)

d	Threads	Product Code	List Price (£)
3/8"/16 - 1"/32	M4	SI NSM 04X	£68.63
1 1/4"/40 - 2"/63	M6	SI NSM 06X	£75.89

Fastening Brass Inserts

Brass threaded inserts to be installed under the valve for bracketing and support (20 pieces)

d	Threads	Product Code	List Price (£)
3/8"/16 - 1"/32	M4	SI NSM 040	£12.42
1 1/4"/40 - 2"/63	M6	SI NSM 060	£14.97

ACCESSORIES

FOR VKD BALL AND FK BUTTERFLY VALVES

Electric Actuators



Type	Voltage	Code	List price
------	---------	------	------------

Electric Actuator - Standard

EA2	100 to 240vAC	HZ EA2 001	£275.94
EA2	24vAC/DC	HZ EA2 002	£275.94
EA3	100 to 240vAC	HZ EA3 001	£394.74
EA3	24vAC/DC	HZ EA3 002	£394.74
EA5	100 to 240vAC	HZ EA5 001	£670.32
EA5	24vAC/DC	HZ EA5 002	£670.32
EA6	100 to 240vAC	HZ EA6 001	£818.21
EA6	24vAC/DC	HZ EA6 002	£818.21
EA8	100 to 240vAC	HZ EA8 001	£1,134.48
EA8	24vAC/DC	HZ EA8 002	£1,134.48

Electric Actuator - Fail Safe Version

EA2	100 to 240vAC	HZ EB2 001	£426.69
EA2	24vAC/DC	HZ EB2 002	£426.69
EA3	100 to 240vAC	HZ EB3 001	£551.34
EA3	24vAC/DC	HZ EB3 002	£551.34
EA5	100 to 240vAC	HZ EB5 001	£892.70
EA5	24vAC/DC	HZ EB5 002	£892.70
EA6	100 to 240vAC	HZ EB6 001	£1,040.04
EA6	24vAC/DC	HZ EB6 002	£1,040.04
EA8	100 to 240vAC	HZ EB8 001	£1,356.41
EA8	24vAC/DC	HZ EB8 002	£1,356.41

Electric Actuator - 4 to 20mA Positioning

EA2	100 to 240vAC	HZ EM2 001	£473.58
EA2	24vAC/DC	HZ EM2 002	£473.58
EA3	100 to 240vAC	HZ EM3 001	£569.70
EA3	24vAC/DC	HZ EM3 002	£569.70
EA5	100 to 240vAC	HZ EM5 001	£1,042.46
EA5	24vAC/DC	HZ EM5 002	£1,042.46
EA6	100 to 240vAC	HZ EM6 001	£1,190.34
EA6	24vAC/DC	HZ EM6 002	£1,190.34

Limit switch setting tool for Electric Actuators EA2 to EA8

	HZ LST 001	£6.42
--	------------	-------

Pneumatic Actuators



Type	Code	List price
------	------	------------

Pneumatic Actuator - Spring Return

PA1	HZ PA1 OSR	£83.40
PA2	HZ PA2 OSR	£134.72
PA3	HZ PA3 OSR	£179.63
PA4	HZ PA4 OSR	£263.02
PA6	HZ PA6 OSR	£538.88
PA7	HZ PA7 OSR	£1,013.61

Pneumatic Actuator - Double Acting

PA1	HZ PA1 ODA	£76.98
PA2	HZ PA2 ODA	£121.89
PA3	HZ PA3 ODA	£153.97
PA4	HZ PA4 ODA	£218.12
PA5	HZ PA5 ODA	£314.34
PA7	HZ PA7 ODA	£769.82

Pneumatic Actuators



Switch box with 2 auxillary limit switches to suit PA1 to PA7 Pneumatic Actuator

Code	List price
With Mechanical limit switches	
HZ SB2 100	£109.06
With intrinsically safe proximity switches	
HZ SB3 100	£290.00
Switch Box mounting plate for PA2 to PA7	
HZ MP4 100	£9.85

Pilot Solenoid Valve 3/2 - 5/2 to suit Pneumatic actuators (Namur mount)

Voltage	Code	List price
240vAC	HZ PS1 240	£93.66
110vAC	HZ PS1 110	£93.66
24vAC	HZ PS1 24A	£93.66
24vDC	HZ PS1 24D	£93.66

For VM Diaphragm Valves



Switch box with 2 auxillary switches to suit VM Diaphragm Valve

Valve Size	Code	List price
FSC		
$\frac{3}{8}$ " - d16	HZ SB5 100	£109.06
$\frac{1}{2}$ " - d20	HZ SB5 100	£109.06
$\frac{3}{4}$ " - d25	HZ SB5 100	£109.06
1" - d32	HZ SB5 100	£109.06
$1\frac{1}{4}$ " - d40	HZ SB5 100	£109.06
$1\frac{1}{2}$ " - d50	HZ SB5 100	£109.06
2" - d63	HZ SB6 100	£109.06
$2\frac{1}{2}$ " - d75	HZ SB6 100	£109.06
3" - d90	HZ SB6 100	£109.06
4" - d110	HZ SB6 100	£109.06

FSO / DA

$\frac{3}{8}$ " - d16	HZ SB7 100	£109.06
$\frac{1}{2}$ " - d20	HZ SB7 100	£109.06
$\frac{3}{4}$ " - d25	HZ SB7 100	£109.06
1" - d32	HZ SB7 100	£109.06
$1\frac{1}{4}$ " - d40	HZ SB7 100	£109.06
$1\frac{1}{2}$ " - d50	HZ SB7 100	£109.06
2" - d63	HZ SB7 100	£109.06
$2\frac{1}{2}$ " - d75	HZ SB7 100	£109.06
3" - d90	HZ SB7 100	£109.06
4" - d110	HZ SB7 100	£109.06

Pilot Solenoid Valve 3/2 to suit Pneumatic actuators (Direct mount)

240vAC	HZ PS2 240	£51.32
110vAC	HZ PS2 110	£51.32
24vAC	HZ PS2 24A	£51.32
24vDC	HZ PS2 24D	£51.32

For Double Acting - 2 off pilot valves are required for correct operation.

The following optional extras are available on request to special order.

Please contact our Valve and Flow control Department to obtain price and availability.

- Visual Position Indicator
- Combined Stroke Limiter, Position Indicator & Manual Override
- Stroke Limiter
- Switch Box with 2 inductive switches
- Combined Stroke Limiter & Position Indicator
- Pneumatic Positioner

Durapipe Flowmeters

We offer a range of variable area flowmeters offering accurate and effective flow measurement solutions. Manufactured in both ABS and PVC-U material, our range of flowmeters are available in standard length and short pattern versions and offer maximum and minimum tell-tale indicators.

- Wide range of flow ranges
- Tube material in Trogamid or Polysulfon
- Optional limit switches
- Standard length and short pattern versions
- Special scales calibrated and printed to order



ACCESSORIES

Variable Area Flowmeters

	Product Code	Price £/each
Limit switches (max)	03 655 009	£73.47
Limit switches (min)	03 655 008	£73.47

Pressure rating – PN10

Options available on request
FPM seals

Max working temperatures
Trogamid tube = 60°C
Polysulfon tube = 70°C

FLOWMETERS

PVC-U IMPERIAL SYSTEM

Standard version - Trogamid tube
Plain with EPDM seals.



Note: * Scale marked in m³/h

Size inch	Flow l/hr	Product code	Price £/each
PVC-U float			
1/2	6.5-65	02 BAA 102	£158.91
1/2	17.5-175	02 BAB 102	£158.91
1	50-500	02 BAC 104	£166.75
1	75-750	02 BAD 104	£166.75
1	125-1250	02 BAE 104	£211.39
1	200-2000	02 BAF 104	£211.39
2*	315-3150	02 BAG 107	£331.49
2*	500-5000	02 BAH 107	£331.49
2*	750-7500	02 BAI 107	£331.49

Size inch	Flow l/hr	Product code	Price £/each
PVC-U float & magnet			
1/2	6.5-65	02 BAV 102	£226.56
1/2	17.5-175	02 BAW 102	£226.56
1	45-450	02 BAX 104	£270.67
1	70-700	02 BAY 104	£270.67
1	110-1100	02 BAZ 104	£313.18
1	175-1750	02 BBA 104	£313.18
2*	315-3150	02 BBB 107	£526.40
2*	500-5000	02 BBC 107	£526.40
2*	750-7500	02 BBD 107	£526.40

Standard version - Polysulfon tube
Plain with EPDM seals



Note: * Scale marked in m³/h

Size inch	Flow l/hr	Product code	Price £/each
PVC-U float			
1/2	6.5-65	02 CAA 102	£186.40
1/2	17.5-175	02 CAB 102	£186.40
1	50-500	02 CAC 104	£215.06
1	75-750	02 CAD 104	£215.21
1	125-1250	02 CAE 104	£270.67
1	200-2000	02 CAF 104	£270.67
2*	315-3150	02 CAG 107	£402.28
2*	500-5000	02 CAH 107	£402.28
2*	750-7500	02 CAI 107	£402.28

Size inch	Flow l/hr	Product code	Price £/each
PVC-U float & magnet			
1/2	6.5-65	02 CAV 102	£259.97
1/2	17.5-175	02 CAW 102	£259.80
1	45-450	02 CAX 104	£317.93
1	70-700	02 CAY 104	£318.25
1	110-1100	02 CAZ 104	£377.54
1	175-1750	02 CBA 104	£377.54
2*	315-3150	02 CBB 107	£640.82
2*	500-5000	02 CBC 107	£640.82
2*	750-7500	02 CBD 107	£640.82

Size inch	Flow l/hr	Product code	Price £/each
Stainless steel float			
1/2	12.5-125	02 BAJ 102	£158.91
1/2	31.5-315	02 BAK 102	£158.91
1	65-650	02 BAL 104	£166.75
1	100-1000	02 BAM 104	£166.75
1	160-1600	02 BAN 104	£211.39
1	250-2500	02 BAO 104	£211.39
2*	400-4000	02 BAP 107	£331.49
2*	650-6500	02 BAQ 107	£331.49
2*	1000-10000	02 BAR 107	£331.49
2*	4000-16000	02 BAS 107	£524.72
2*	6000-20000	02 BAT 107	£524.72
2*	8000-25000	02 BAU 107	£591.36

Size inch	Flow l/hr	Product code	Price £/each
Stainless steel float & magnet			
1/2	12-120	02 BBE 102	£226.56
1/2	30-300	02 BBF 102	£226.56
1	60-600	02 BBG 104	£270.67
1	95-950	02 BBH 104	£270.67
1	150-1500	02 BBI 104	£313.18
1	200-2000	02 BBJ 104	£313.18
2*	380-3800	02 BBK 107	£526.40
2*	640-6400	02 BBL 107	£526.40
2*	950-9500	02 BBM 107	£526.40
2*	4000-16000	02 BBN 107	£812.92
2*	6000-19000	02 BBO 107	£812.92
2*	8000-24000	02 BBP 107	£887.88

Size inch	Flow l/hr	Product code	Price £/each
Stainless steel float			
1/2	12.5-125	02 CAJ 102	£186.56
1/2	31.5-315	02 CAK 102	£186.56
1	65-650	02 CAL 104	£215.06
1	100-1000	02 CAM 104	£215.06
1	160-1600	02 CAN 104	£270.67
1	250-2500	02 CAO 104	£270.67
2*	400-4000	02 CAP 107	£402.28
2*	650-6500	02 CAQ 107	£402.28
2*	1000-10000	02 CAR 107	£402.28
2*	4000-16000	02 CAS 107	£707.96
2*	6000-20000	02 CAT 107	£707.96
2*	8000-25000	02 CAU 107	£761.27

Size inch	Flow l/hr	Product code	Price £/each
Stainless steel float & magnet			
1/2	12-120	02 CBE 102	£261.35
1/2	30-300	02 CBF 102	£261.35
1	60-600	02 CBG 104	£320.16
1	95-950	02 CBH 104	£320.16
1	150-1500	02 CBI 104	£379.80
1	200-2000	02 CBJ 104	£379.80
2*	380-3800	02 CBK 107	£644.65
2*	640-6400	02 CBL 107	£644.65
2*	950-9500	02 CBM 107	£644.65
2*	4000-16000	02 CBN 107	£1,021.14
2*	6000-19000	02 CBO 107	£1,021.14
2*	8000-24000	02 CBP 107	£1,057.77

PVC-U IMPERIAL SYSTEM

Short version - Trogamid tube Plain with EPDM seals.



Size inch	Flow l/hr	Product code	Price £/each
PVC-U float			
1/2	2-20	02 BBQ 102	£96.94
1/2	3.5-35	02 BBR 102	£96.94
1/2	5.5-55	02 BBS 102	£96.94
1/2	10-100	02 BBT 102	£96.94
1/2	14-140	02 BBU 102	98.45
1	30-300	02 BBV 104	£114.61
1	50-500	02 BBW 104	£114.61
1	75-750	02 BBX 104	£114.61
1	120-1200	02 BBY 104	£114.61

Size inch	Flow l/hr	Product code	Price £/each
PVC-U float & magnet			
1/2	2-20	02 BCA 102	£137.09
1/2	3.5-35	02 BCB 102	£137.09
1/2	5.5-55	02 BCC 102	£137.09
1/2	9-90	02 BCD 102	£137.09
1/2	14-140	02 BCE 102	£156.75
1	25-250	02 BCF 104	£186.89
1	45-450	02 BCG 104	£187.07
1	65-650	02 BCH 104	£187.07
1	100-1000	02 BCI 104	£186.89

Size inch	Flow l/hr	Product code	Price £/each
Stainless steel float			
1/2	4-40	02 BCJ 102	£96.94
1/2	6.5-65	02 BCK 102	£96.94
1/2	10-100	02 BCL 102	£96.94
1/2	16-160	02 BCM 102	£96.94
1/2	25-250	02 BCN 102	£98.45
1	40-400	02 BCO 104	£114.61
1	65-650	02 BCP 104	£114.61
1	100-1000	02 BCQ 104	£114.61
1	160-1600	02 BCR 104	£114.61

Size inch	Flow l/hr	Product code	Price £/each
Stainless steel float & magnet			
1/2	4-40	02 BCS 102	£137.09
1/2	6.5-65	02 BCT 102	£137.09
1/2	9.5-95	02 BCU 102	£137.09
1/2	16-160	02 BCV 102	£137.09
1/2	24-240	02 BCW 102	£156.75
1	40-400	02 BCX 104	£186.89
1	65-650	02 BCY 104	£186.89
1	100-1000	02 BCZ 104	£187.07
1	160-1600	02 BDA 104	£178.92

Short version - Polysulfon tube Plain with EPDM seals



Size inch	Flow l/hr	Product code	Price £/each
PVC-U float			
1/2	2-20	02 CDA 102	£100.45
1/2	3.5-35	02 CDB 102	£100.45
1/2	5.5-55	02 CDC 102	£100.45
1/2	10-100	02 CDD 102	£100.45
1/2	14-140	02 CDE 102	£102.44
1	30-300	02 CDF 104	£124.77
1	50-500	02 CDG 104	£124.77
1	75-750	02 CDH 104	£124.77
1	120-1200	02 CDI 104	£124.77

Size inch	Flow l/hr	Product code	Price £/each
PVC-U float & magnet			
1/2	2-20	02 CDJ 102	£140.77
1/2	3.5-35	02 CDK 102	£140.77
1/2	5.5-55	02 CDL 102	£140.77
1/2	9-90	02 CDM 102	£140.77
1/2	14-140	02 CDN 102	£162.58
1	25-250	02 CDO 104	£196.74
1	45-450	02 CDP 104	£196.74
1	65-650	02 CDQ 104	£196.74
1	100-1000	02 CDR 104	£196.74

Size inch	Flow l/hr	Product code	Price £/each
Stainless steel float			
1/2	4-40	02 CDS 102	£100.45
1/2	6.5-65	02 CDT 102	£100.45
1/2	10-100	02 CDU 102	£100.45
1/2	16-160	02 CDV 102	£100.45
1/2	25-250	02 CDW 102	£102.44
1	40-400	02 CDX 104	£124.77
1	65-650	02 CDY 104	£124.77
1	100-1000	02 CDZ 104	£124.77
1	160-1600	02 CEA 104	£124.77

Size inch	Flow l/hr	Product code	Price £/each
Stainless steel float & magnet			
1/2	4-40	02 CEB 102	£140.77
1/2	6.5-65	02 CEC 102	£140.77
1/2	9.5-95	02 CED 102	£140.77
1/2	16-160	02 CEE 102	£140.77
1/2	24-240	02 CEF 102	£162.75
1	40-400	02 CEG 104	£196.74
1	65-650	02 CEH 104	£196.74
1	100-1000	02 CEI 104	£196.74
1	160-1600	02 CEJ 104	£196.74

FLOWMETERS

PVC-U METRIC SYSTEM

Standard version - Trogamid tube

Plain with EPDM seals



Note: * Scale marked in m³/h

Size mm	Flow l/hr	Product code	Price £/each
PVC-U float			
20	6.5-65	33 BAA 306	£158.91
20	17.5-175	33 BAB 306	£158.95
32	50-500	33 BAC 308	£166.74
32	75-750	33 BAD 308	£166.75
32	125-1250	33 BAE 308	£211.42
32	200-2000	33 BAF 308	£211.42
63*	315-3150	33 BAG 311	£331.61
63*	500-5000	33 BAH 311	£331.49
63*	750-7500	33 BAI 311	£331.49

Size mm	Flow l/hr	Product code	Price £/each
PVC-U float & magnet			
20	6.5-65	33 BAV 306	£226.55
20	17.5-175	33 BAW 306	£226.55
32	45-450	33 BAX 308	£270.68
32	70-700	33 BAY 308	£270.68
32	110-1100	33 BAZ 308	£313.17
32	175-1750	33 BBA 308	£313.17
63*	315-3150	33 BBB 311	£526.40
63*	500-5000	33 BBC 311	£526.40
63*	750-7500	33 BBD 311	£526.40

Standard version - Polysulfon tube

Plain with EPDM seals



Note: * Scale marked in m³/h

Size mm	Flow l/hr	Product code	Price £/each
PVC-U float			
20	6.5-65	33 CAA 306	£186.40
20	17.5-175	33 CAB 306	£186.40
32	50-500	33 CAC 308	£215.15
32	75-750	33 CAD 308	£215.21
32	125-1250	33 CAE 308	£270.68
32	200-2000	33 CAF 308	£270.68
63*	315-3150	33 CAG 311	£402.28
63*	500-5000	33 CAH 311	£402.28
63*	750-7500	33 CAI 311	£402.28

Size mm	Flow l/hr	Product code	Price £/each
PVC-U float & magnet			
20	6.5-65	33 CAV 306	£261.53
20	17.5-175	33 CAW 306	£261.35
32	45-450	33 CAX 308	£319.83
32	70-700	33 CAY 308	£320.16
32	110-1100	33 CAZ 308	£379.80
32	175-1750	33 CBA 308	£379.80
63*	315-3150	33 CBB 311	£644.65
63*	500-5000	33 CBC 311	£644.65
63*	750-7500	33 CBD 311	£644.65

Size mm	Flow l/hr	Product code	Price £/each
Stainless steel float			
20	12.5-125	33 BAJ 306	£158.91
20	31.5-315	33 BAK 306	£158.91
32	65-650	33 BAL 308	£166.76
32	100-1000	33 BAM 308	£166.76
32	160-1600	33 BAN 308	£211.39
32	250-2500	33 BAO 308	£211.42
63*	400-4000	33 BAP 311	£331.60
63*	650-6500	33 BAQ 311	£331.50
63*	1000-10000	33 BAR 311	£331.50
63*	4000-16000	33 BAS 311	£524.72
63*	6000-20000	33 BAT 311	£524.72
63*	8000-25000	33 BAU 311	£591.35

Size mm	Flow l/hr	Product code	Price £/each
Stainless steel float & magnet			
20	12-120	33 BBE 306	£226.55
20	30-300	33 BBF 306	£226.55
32	60-600	33 BBG 308	£270.68
32	95-950	33 BBH 308	£270.68
32	150-1500	33 BBI 308	£313.17
32	200-2000	33 BBJ 308	£313.17
63*	380-3800	33 BBK 311	£526.40
63*	640-6400	33 BBL 311	£526.40
63*	950-9500	33 BBM 311	£526.40
63*	4000-16000	33 BBN 311	£812.91
63*	6000-19000	33 BBO 311	£812.91
63*	8000-24000	33 BBP 311	£887.87

Size mm	Flow l/hr	Product code	Price £/each
Stainless steel float			
20	12.5-125	33 CAJ 306	£186.57
20	31.5-315	33 CAK 306	£186.57
32	65-650	33 CAL 308	£215.06
32	100-1000	33 CAM 308	£204.88
32	160-1600	33 CAN 308	£270.68
32	250-2500	33 CAO 308	£270.68
63*	400-4000	33 CAP 311	£402.28
63*	650-6500	33 CAQ 311	£402.28
63*	1000-10000	33 CAR 311	£402.28
63*	4000-16000	33 CAS 311	£707.97
63*	6000-20000	33 CAT 311	£707.97
63*	8000-25000	33 CAU 311	£761.27

Size mm	Flow l/hr	Product code	Price £/each
Stainless steel float & magnet			
20	12-120	33 CBE 306	£261.35
20	30-300	33 CBF 306	£261.35
32	60-600	33 CBG 308	£320.16
32	95-950	33 CBH 308	£320.16
32	150-1500	33 CBI 308	£379.80
32	200-2000	33 CBJ 308	£379.80
63*	380-3800	33 CBK 311	£644.65
63*	640-6400	33 CBL 311	£644.65
63*	950-9500	33 CBM 311	£644.65
63*	4000-16000	33 CBN 311	£1,021.14
63*	6000-19000	33 CBO 311	£1,021.14
63*	8000-24000	33 CBP 311	£1,057.77

PVC-U METRIC SYSTEM

**Short version -
Trogamid tube**
Plain with EPDM seals



Size mm	Flow l/hr	Product code	Price £/each
PVC-U float			
20	2-20	33 BBO 306	£96.94
20	3.5-35	33 BBR 306	£96.94
20	5.5-55	33 BBS 306	£96.94
20	10-100	33 BBT 306	£96.94
20	14-140	33 BBU 306	£98.45
32	30-300	33 BBV 308	£114.61
32	50-500	33 BBW 308	£114.61
32	75-750	33 BBX 308	£114.61
32	120-1200	33 BBY 308	£114.61

Size mm	Flow l/hr	Product code	Price £/each
PVC-U float & magnet			
20	2-20	33 BCA 306	£137.09
20	3.5-35	33 BCB 306	£137.09
20	5.5-55	33 BCC 306	£137.09
20	9-90	33 BCD 306	£137.09
20	14-140	33 BCE 306	£156.75
32	25-250	33 BCF 308	£186.89
32	45-450	33 BCG 308	£187.07
32	65-650	33 BCH 308	£187.07
32	100-1000	33 BCI 308	£186.89

Size mm	Flow l/hr	Product code	Price £/each
Stainless steel float			
20	4-40	33 BCJ 306	£96.94
20	6.5-65	33 BCK 306	£96.94
20	10-100	33 BCL 306	£96.94
20	16-160	33 BCM 306	£92.61
20	25-250	33 BCN 306	£98.45
32	40-400	33 BCO 308	£114.61
32	65-650	33 BCP 308	£114.61
32	100-1000	33 BCQ 308	£114.61
32	160-1600	33 BCR 308	£114.61

Size mm	Flow l/hr	Product code	Price £/each
Stainless steel float & magnet			
20	4-40	33 BCS 306	£137.09
20	6.5-65	33 BCT 306	£137.09
20	9.5-95	33 BCU 306	£137.09
20	16-160	33 BCV 306	£137.09
20	24-240	33 BCW 306	£156.75
32	40-400	33 BCX 308	£186.89
32	65-650	33 BCY 308	£186.89
32	100-1000	33 BCZ 308	£187.07
32	160-1600	33 BDA 308	£178.92

**Short version -
Polysulfon tube**
Plain with EPDM seals



Size mm	Flow l/hr	Product code	Price £/each
PVC-U float			
20	2-20	33 CDA 306	£100.42
20	3.5-35	33 CDB 306	£100.45
20	5.5-55	33 CDC 306	£100.45
20	10-100	33 CDD 306	£100.45
20	14-140	33 CDE 306	£102.44
32	30-300	33 CDF 308	£124.77
32	50-500	33 CDG 308	£124.77
32	75-750	33 CDH 308	£124.77
32	120-1200	33 CDI 308	£124.77

Size mm	Flow l/hr	Product code	Price £/each
PVC-U float & magnet			
20	2-20	33 CDJ 306	£140.77
20	3.5-35	33 CDK 306	£140.77
20	5.5-55	33 CDL 306	£140.77
20	9-90	33 CDM 306	£140.77
20	14-140	33 CDN 306	£162.58
32	25-250	33 CDO 308	£196.74
32	45-450	33 CDP 308	£196.74
32	65-650	33 CDQ 308	£196.74
32	100-1000	33 CDR 308	£196.74

Size mm	Flow l/hr	Product code	Price £/each
Stainless steel float			
20	4-40	33 CDS 306	£100.45
20	6.5-65	33 CDT 306	£100.45
20	10-100	33 CDU 306	£100.45
20	16-160	33 CDV 306	£100.45
20	25-250	33 CDW 306	£102.44
32	40-400	33 CDX 308	£124.77
32	65-650	33 CDY 308	£124.77
32	100-1000	33 CDZ 308	£124.71
32	160-1600	33 CEA 308	£124.71

Size mm	Flow l/hr	Product code	Price £/each
Stainless steel float & magnet			
20	4-40	33 CEB 306	£140.77
20	6.5-65	33 CEC 306	£140.77
20	9.5-95	33 CED 306	£140.77
20	16-160	33 CEE 306	£140.77
20	24-240	33 CEF 306	£162.75
32	40-400	33 CEG 308	£196.74
32	65-650	33 CEH 308	£196.74
32	100-1000	33 CEI 308	£196.74
32	160-1600	33 CEJ 308	£196.74

FLOWMETERS

ABS IMPERIAL SYSTEM

Standard version - Trogamid tube Plain with EPDM seals.



* Note: Scale marked in m³/h

Size inch	Flow l/hr	Product code	Price £/each
PVC-U float			
1/2	6.5-65	01 BAA 102	£158.91
1/2	17.5-175	01 BAB 102	£158.91
1	50-500	01 BAC 104	£166.75
1	75-750	01 BAD 104	£166.75
1	125-1250	01 BAE 104	£211.56
1	200-2000	01 BAF 104	£211.39
2*	315-3150	01 BAG 107	£331.49
2*	500-5000	01 BAH 107	£331.49
2*	750-7500	01 BAI 107	£331.49

Size inch	Flow l/hr	Product code	Price £/each
Stainless steel float			
1/2	12.5-125	01 BAJ 102	£152.09
1/2	31.5-315	01 BAK 102	£158.91
1	65-650	01 BAL 104	£166.75
1	100-1000	01 BAM 104	£166.75
1	160-1600	01 BAN 104	£211.39
1	250-2500	01 BAO 104	£211.39
2*	400-4000	01 BAP 107	£317.32
2*	650-6500	01 BAQ 107	£331.49
2*	1000-10000	01 BAR 107	£331.49
2*	4000-16000	01 BAS 107	£524.72
2*	6000-20000	01 BAT 107	£524.72
2*	8000-25000	01 BAU 107	£591.36

Size inch	Flow l/hr	Product code	Price £/each
PVC-U float & magnet			
1/2	6.5-65	01 BAV 102	£215.55
1/2	17.5-175	01 BAW 102	£215.55
1	45-450	01 BAX 104	£270.68
1	70-700	01 BAY 104	£271.52
1	110-1100	01 BAZ 104	£313.17
1	175-1750	01 BBA 104	£313.99
2*	315-3150	01 BBB 107	£524.72
2*	500-5000	01 BBC 107	£524.72
2*	750-7500	01 BBD 107	£524.72

Size inch	Flow l/hr	Product code	Price £/each
Stainless steel float & magnet			
1/2	12-120	01 BBE 102	£226.55
1/2	30-300	01 BBF 102	£226.55
1	60-600	01 BBG 104	£271.52
1	95-950	01 BBH 104	£271.52
1	150-1500	01 BBI 104	£313.17
1	200-2000	01 BBJ 104	£313.17
2*	380-3800	01 BBK 107	£524.72
2*	640-6400	01 BBL 107	£524.72
2*	950-9500	01 BBM 107	£526.40
2*	4000-16000	01 BBN 107	£812.91
2*	6000-19000	01 BBO 107	£812.91
2*	8000-24000	01 BBP 107	£887.87

Standard version - Polysulfon tube Plain with EPDM seals



* Note: Scale marked in m³/h

Size inch	Flow l/hr	Product code	Price £/each
PVC-U float			
1/2	6.5-65	01 CAA 102	£186.57
1/2	17.5-175	01 CAB 102	£186.57
1	50-500	01 CAC 104	£214.88
1	75-750	01 CAD 104	£215.06
1	125-1250	01 CAE 104	£270.68
1	200-2000	01 CAF 104	£270.68
2*	315-3150	01 CAG 107	£403.13
2*	500-5000	01 CAH 107	£403.13
2*	750-7500	01 CAI 107	£403.13

Size inch	Flow l/hr	Product code	Price £/each
Stainless steel float			
1/2	12.5-125	01 CAJ 102	£186.57
1/2	31.5-315	01 CAK 102	£186.57
1	65-650	01 CAL 104	£214.88
1	100-1000	01 CAM 104	£205.89
1	160-1600	01 CAN 104	£271.52
1	250-2500	01 CAO 104	£270.68
2*	400-4000	01 CAP 107	£403.13
2*	650-6500	01 CAQ 107	£403.13
2*	1000-10000	01 CAR 107	£403.13
2*	4000-16000	01 CAS 107	£707.97
2*	6000-20000	01 CAT 107	£707.97
2*	8000-25000	01 CAU 107	£707.97

Size inch	Flow l/hr	Product code	Price £/each
PVC-U float & magnet			
1/2	6.5-65	01 CAV 102	£259.87
1/2	17.5-175	01 CAW 102	£259.87
1	45-450	01 CAX 104	£319.83
1	70-700	01 CAY 104	£319.83
1	110-1100	01 CAZ 104	£379.80
1	175-1750	01 CBA 104	£379.80
2*	315-3150	01 CBB 107	£644.65
2*	500-5000	01 CBC 107	£644.65
2*	750-7500	01 CBD 107	£644.65

Size inch	Flow l/hr	Product code	Price £/each
Stainless steel float & magnet			
1/2	12-120	01 CBE 102	£259.87
1/2	30-300	01 CBF 102	£259.87
1	60-600	01 CBG 104	£319.83
1	95-950	01 CBH 104	£319.83
1	150-1500	01 CBI 104	£379.80
1	200-2000	01 CBJ 104	£379.80
2*	380-3800	01 CBK 107	£644.65
2*	640-6400	01 CBL 107	£644.65
2*	950-9500	01 CBM 107	£644.65
2*	4000-16000	01 CBN 107	£1,021.14
2*	6000-19000	01 CBO 107	£1,021.14
2*	8000-24000	01 CBP 107	£1,021.14

ABS IMPERIAL SYSTEM

Short version - Trogamid tube Plain with EPDM seals



Size inch	Flow l/hr	Product code	Price £/each
PVC-U float			
1/2	2-20	01 BBO 102	£96.95
1/2	3.5-35	01 BBR 102	£96.61
1/2	5.5-55	01 BBS 102	£96.95
1/2	10-100	01 BBT 102	£92.29
1/2	14-140	01 BBU 102	£94.28
1	30-300	01 BBV 104	£114.61
1	50-500	01 BBW 104	£114.61
1	75-750	01 BBX 104	£114.61
1	120-1200	01 BBY 104	£114.95

Size inch	Flow l/hr	Product code	Price £/each
Stainless steel float			
1/2	4-40	01 BCJ 102	£96.95
1/2	6.5-65	01 BCK 102	£96.95
1/2	10-100	01 BCL 102	£96.61
1/2	16-160	01 BCM 102	£92.60
1/2	25-250	01 BCN 102	£98.46
1	40-400	01 BCO 104	£114.61
1	65-650	01 BCP 104	£114.61
1	100-1000	01 BCQ 104	£114.61
1	160-1600	01 BCR 104	£114.61

Size inch	Flow l/hr	Product code	Price £/each
PVC-U float & magnet			
1/2	2-20	01 BCA 102	£136.60
1/2	3.5-35	01 BCB 102	£136.60
1/2	5.5-55	01 BCC 102	£136.60
1/2	9-90	01 BCD 102	£136.60
1/2	14-140	01 BCE 102	£156.59
1	25-250	01 BCF 104	£186.57
1	45-450	01 BCG 104	£186.57
1	65-650	01 BCH 104	£186.57
1	100-1000	01 BCI 104	£186.57

Size inch	Flow l/hr	Product code	Price £/each
Stainless steel float & magnet			
1/2	4-40	01 BCS 102	£136.60
1/2	6-60	01 BCT 102	£136.60
1/2	9.5-95	01 BCU 102	£136.60
1/2	16-160	01 BCV 102	£136.60
1/2	24-240	01 BCW 102	£156.59
1	40-400	01 BCX 104	£186.57
1	65-650	01 BCY 104	£186.89
1	100-1000	01 BCZ 104	£186.57
1	160-1600	01 BDA 104	£186.57

Short version - Polysulfon tube Plain with EPDM seals



Size inch	Flow l/hr	Product code	Price £/each
PVC-U float			
1/2	2-20	01 CDA 102	£100.61
1/2	3.5-35	01 CDB 102	£99.95
1/2	5.5-55	01 CDC 102	£99.95
1/2	10-100	01 CDD 102	£99.95
1/2	14-140	01 CDE 102	£103.28
1	30-300	01 CDF 104	£124.93
1	50-500	01 CDG 104	£124.93
1	75-750	01 CDH 104	£124.93
1	120-1200	01 CDI 104	£124.93

Size inch	Flow l/hr	Product code	Price £/each
Stainless steel float			
1/2	4-40	01 CDS 102	£99.95
1/2	6.5-65	01 CDT 102	£99.95
1/2	10-100	01 CDU 102	£99.95
1/2	16-160	01 CDV 102	£99.95
1/2	25-250	01 CDW 102	£103.28
1	40-400	01 CDX 104	£124.77
1	65-650	01 CDY 104	£124.77
1	100-1000	01 CDZ 104	£124.77
1	160-1600	01 CEA 104	£124.77

Size inch	Flow l/hr	Product code	Price £/each
PVC-U float & magnet			
1/2	2-20	01 CDJ 102	£141.60
1/2	3.5-35	01 CDK 102	£141.60
1/2	5.5-55	01 CDL 102	£141.60
1/2	9-90	01 CDM 102	£141.60
1/2	14-140	01 CDN 102	£163.24
1	25-250	01 CDO 104	£196.56
1	45-450	01 CDP 104	£196.56
1	65-650	01 CDQ 104	£196.56
1	100-1000	01 CDR 104	£196.56

Size inch	Flow l/hr	Product code	Price £/each
Stainless steel float & magnet			
1/2	4-40	01 CEB 102	£141.60
1/2	6-60	01 CEC 102	£141.60
1/2	9.5-95	01 CED 102	£141.60
1/2	16-160	01 CEE 102	£141.60
1/2	24-240	01 CEF 102	£163.24
1	40-400	01 CEG 104	£196.56
1	65-650	01 CEH104	£196.56
1	100-1000	01 CEI 104	£196.56
1	160-1600	01 CEJ 104	£196.56

FLOWMETERS

ABS METRIC SYSTEM

Standard version - Trogamid tube
Plain with EPDM seals



* Note: Scale marked in m³/h

Size mm	Flow l/hr	Product code	Price £/each
PVC-U float			
20	6.5-65	11 BAA 306	£158.91
20	17.5-175	11 BAB 306	£158.91
32	50-500	11 BAC 308	£166.76
32	75-750	11 BAD 308	£166.76
32	125-1250	11 BAE 308	£211.39
32	200-2000	11 BAF 308	£211.39
63*	315-3150	11 BAG 311	£331.50
63*	500-5000	11 BAH 311	£331.50
63*	750-7500	11 BAI 311	£331.50

Size mm	Flow l/hr	Product code	Price £/each
PVC-U float & magnet			
20	6.5-65	11 BAV 306	£226.55
20	17.5-175	11 BAW 306	£226.55
32	45-450	11 BAX 308	£271.52
32	70-700	11 BAY 308	£271.52
32	110-1100	11 BAZ 308	£313.17
32	175-1750	11 BBA 308	£313.17
63*	315-3150	11 BBB 311	£524.72
63*	500-5000	11 BBC 311	£524.72
63*	750-7500	11 BBD 311	£524.72

Size mm	Flow l/hr	Product code	Price £/each
PVC-U float			
20	6.5-65	11 CAA 306	£186.57
20	17.5-175	11 CAB 306	£186.57
32	50-500	11 CAC 308	£214.88
32	75-750	11 CAD 308	£214.88
32	125-1250	11 CAE 308	£271.52
32	200-2000	11 CAF 308	£271.52
63*	315-3150	11 CAG 311	£403.13
63*	500-5000	11 CAH 311	£403.13
63*	750-7500	11 CAI 311	£403.13

Size mm	Flow l/hr	Product code	Price £/each
PVC-U float & magnet			
20	6.5-65	11 CAV 306	£259.87
20	17.5-175	11 CAW 306	£259.87
32	45-450	11 CAX 308	£319.83
32	70-700	11 CAY 308	£319.83
32	110-1100	11 CAZ 308	£379.80
32	175-1750	11 CBA 308	£379.80
63*	315-3150	11 CBB 311	£644.65
63*	500-5000	11 CBC 311	£644.65
63*	750-7500	11 CBD 311	£644.65

Size mm	Flow l/hr	Product code	Price £/each
Stainless steel float			
20	12.5-125	11 BAJ 306	£158.91
20	31.5-315	11 BAK 306	£158.91
32	65-650	11 BAL 308	£166.75
32	100-1000	11 BAM 308	£166.75
32	160-1600	11 BAN 308	£211.39
32	250-2500	11 BAO 308	£209.89
63*	400-4000	11 BAP 311	£331.49
63*	650-6500	11 BAQ 311	£331.49
63*	1000-10000	11 BAR 311	£331.49
63*	4000-16000	11 BAS 311	£524.72
63*	6000-20000	11 BAT 311	£524.72
63*	8000-25000	11 BAU 311	£524.72

Size mm	Flow l/hr	Product code	Price £/each
Stainless steel float & magnet			
20	12-120	11 BBE 306	£226.55
20	30-300	11 BBF 306	£226.55
32	60-600	11 BBG 308	£270.68
32	95-950	11 BBH 308	£271.52
32	150-1500	11 BBI 308	£313.17
32	200-2000	11 BBJ 308	£313.17
63*	380-3800	11 BBK 311	£524.72
63*	640-6400	11 BBL 311	£524.72
63*	950-9500	11 BBM 311	£524.72
63*	400-16000	11 BBN 311	£812.91
63*	6000-19000	11 BBO 311	£812.91
63*	8000-24000	11 BBP 311	£887.87

Size mm	Flow l/hr	Product code	Price £/each
Stainless steel float			
20	12.5-125	11 CAJ 306	£186.57
20	31.5-315	11 CAK 306	£186.57
32	65-650	11 CAL 308	£214.88
32	100-1000	11 CAM 308	£214.88
32	160-1600	11 CAN 308	£271.52
32	250-2500	11 CAO 308	£271.52
63*	400-4000	11 CAP 311	£403.13
63*	650-6500	11 CAQ 311	£403.13
63*	1000-10000	11 CAR 311	£403.13
63*	4000-16000	11 CAS 311	£707.97
63*	6000-12000	11 CAT 311	£707.97
63*	8000-25000	11 CAU 311	£707.97

Size mm	Flow l/hr	Product code	Price £/each
Stainless steel float & magnet			
20	12-120	11 CBE 306	£259.87
20	30-300	11 CBF 306	£259.87
32	60-600	11 CBG 308	£319.83
32	95-950	11 CBH 308	£319.83
32	150-1500	11 CBI 308	£379.80
32	200-2000	11 CBJ 308	£379.80
63*	380-3800	11 CBK 311	£644.65
63*	640-6400	11 CBL 311	£644.65
63*	950-9500	11 CBM 311	£644.65
63*	4000-16000	11 CBN 311	£1,021.14
63*	6000-19000	11 CBO 311	£1,021.14
63*	8000-24000	11 CBP 311	£1,021.14

Standard version - Polysulfon tube
Plain with EPDM seals



* Note: Scale marked in m³/h

ABS METRIC SYSTEM

Short version - Trogamid tube Plain with EPDM seals



Size mm	Flow l/hr	Product code	Price £/each
PVC-U float			
20	2-20	11 BBO 306	£96.61
20	3.5-35	11 BBR 306	£96.61
20	5.5-55	11 BBS 306	£96.61
20	10-100	11 BBT 306	£96.61
20	14-140	11 BBU 306	£98.29
32	30-300	11 BBV 308	£114.94
32	50-500	11 BBW 308	£114.94
32	75-750	11 BBX 308	£138.59
32	120-1200	11 BBY 308	£114.94

Size mm	Flow l/hr	Product code	Price £/each
Stainless steel float			
20	4-40	11 BCJ 306	£96.61
20	6.5-65	11 BCK 306	£96.61
20	10-100	11 BCL 306	£96.61
20	16-160	11 BCM 306	£117.10
20	25-250	11 BCN 306	£98.29
32	40-400	11 BCO 308	£114.94
32	65-650	11 BCP 308	£114.94
32	100-1000	11 BCQ 308	£114.94
32	160-1600	11 BCR 308	£114.94

Size mm	Flow l/hr	Product code	Price £/each
PVC-U float & magnet			
20	2-20	11 BCA 306	£136.60
20	3.5-35	11 BCB 306	£136.60
20	5.5-55	11 BCC 306	£136.60
20	9-90	11 BCD 306	£136.60
20	14-140	11 BCE 306	£156.59
32	25-250	11 BCF 308	£186.57
32	45-450	11 BCG 308	£186.57
32	65-650	11 BCH 308	£186.57
32	100-1000	11 BCI 308	£186.57

Size mm	Flow l/hr	Product code	Price £/each
Stainless steel float & magnet			
20	4-40	11 BCS 306	£136.60
20	6.5-65	11 BCT 306	£136.60
20	9.5-95	11 BCU 306	£136.60
20	16-160	11 BCV 306	£136.60
20	24-240	11 BCW 306	£156.59
32	40-400	11 BCX 308	£186.57
32	65-650	11 BCY 308	£186.57
32	100-1000	11 BCZ 308	£186.57
32	160-1600	11 BDA 308	£186.57

Short version - Polysulfon tube Plain with EPDM seals.



Size mm	Flow l/hr	Product code	Price £/each
PVC-U float			
20	2-20	11 CDA 306	£99.95
20	3.5-35	11 CDB 306	£99.95
20	5.5-55	11 CDC 306	£99.95
20	10-100	11 CDD 306	£99.95
20	14-140	11 CDE 306	£103.28
32	30-300	11 CDF 308	£124.93
32	50-500	11 CDG 308	£124.93
32	75-750	11 CDH 308	£124.93
32	120-1200	11 CDI 308	£124.93

Size mm	Flow l/hr	Product code	Price £/each
Stainless steel float			
20	4-40	11 CDS 306	£99.95
20	6.5-65	11 CDT 306	£99.95
20	10-100	11 CDU 306	£99.95
20	16-160	11 CDV 306	£99.95
20	25-250	11 CDW 306	£103.28
32	40-400	11 CDX 308	£124.93
32	65-650	11 CDY 308	£124.93
32	100-1000	11 CDZ 308	£124.93
32	160-1600	11 CEA 308	£124.93

Size mm	Flow l/hr	Product code	Price £/each
PVC-U float & magnet			
20	2-20	11 CDJ 306	£141.60
20	3.5-35	11 CDK 306	£141.60
20	5.5-55	11 CDL 306	£141.60
20	9-90	11 CDM 306	£141.60
20	14-140	11 CDN 306	£163.24
32	25-250	11 CDO 308	£196.56
32	45-450	11 CDP 308	£196.56
32	65-650	11 CDQ 308	£196.56
32	100-1000	11 CDR 308	£196.56

Size mm	Flow l/hr	Product code	Price £/each
Stainless steel float & magnet			
20	4-40	11 CEB 306	£141.60
20	6-60	11 CEC 306	£141.60
20	9.5-95	11 CED 306	£141.60
20	16-160	11 CEE 306	£141.60
20	24-240	11 CEF 306	£163.24
32	40-400	11 CEG 308	£196.56
32	65-650	11 CEH 308	£196.56
32	100-1000	11 CEI 308	£196.56
32	160-1600	11 CEJ 308	£196.56

Durapipe FlowX3

The FlowX3 family offers a complete range of flow sensors ready to be interfaced with monitors, indicators and transmitters. The range includes both paddlewheel and electromagnetic flow sensors which can be used as an important tool when measuring flow for waste water, reverse osmosis, de-ozonation, and potable water applications.

Available with a choice of chemically resistant bodies, the FlowX3 is available with either paddlewheel or electromagnetic flow sensors.



For further information contact our Valve & Flow Control Department on
01543 272424

DURAPIPE UK CONDITIONS OF SALE

1. **DEFINITIONS:**

'Seller' shall mean Glynwed Pipe Systems Limited, registered in England under number 1698059. 'Buyer' shall mean any company, organisation or individual to whom a quotation is offered, or whose order is accepted by the Seller.
2. **CONDITIONS:**

All offers, quotations, estimates, acceptances and contracts are subject to these Conditions of Business and any terms or conditions which any other person shall seek to impose or make part of any contract shall, so far as is inconsistent with these Conditions of Business, not apply unless expressly agreed by the Seller in writing. The headings in these conditions are for convenience only and shall not affect their interpretation.
3. **QUOTATIONS AND PRICE VARIATION:**
 - a) Any quotation given by the Seller is an invitation to the Buyer to make an offer only and no order of the Buyer placed with the Seller in pursuance of a quotation or otherwise shall be binding on the Seller unless and until it is accepted in writing by the Seller.
 - b) Unless stated otherwise, all quotations and published price lists are ex works, exclusive of VAT and shall remain valid for 30 days or such a period as may be quoted but nevertheless the Seller may amend or withdraw any quotation by written or oral notice. Quotations may be varied if the Buyer makes variations in his specifications.
4. **STATEMENTS OR REPRESENTATIONS TO THE BUYER:**

If any statement or representation has been made to the Buyer upon which the Buyer relies other than in the documents enclosed with the Seller's quotation, the Buyer must set out that statement or representation in a document to be attached to or endorsed on the order in which case the Seller may submit a new quotation.
5. **DELIVERY - TIME:**
 - a) Any period for delivery given at any time and in any manner by the Seller is an estimate only and is not binding on the Seller. Delivery periods are normally calculated from the later of:
 - i) acceptance of order; or
 - ii) where applicable, the receipt by the Seller of a detailed specification or drawings.
 - b) Time shall not be deemed to be of the essence of the contract. Failure by the Seller to meet any quoted delivery period for any part or the whole of the order shall not entitle the Buyer to rescind the contract or to claim damages of any nature.
 - c) The Seller will endeavour to comply with reasonable requests by the Buyer for postponement of delivery but shall be under no obligation to do so. Where delivery is postponed otherwise than due to default by the Seller the Buyer shall pay all costs and expenses including a reasonable charge for storage and transportation occasioned thereby and an extra charge for split delivery if applicable.
 - d) The Buyer will receive delivery of any consignment between the hours of 8.00am and 4.00pm Monday to Friday inclusive, unless otherwise agreed in writing. Cost incurred by the Seller arising from the Buyer's refusal to accept consignments within the agreed hours shall be borne by the Buyer.
6. **DELIVERY AND RISK:**
 - a) Except where stated to the contrary in the contract, delivery shall be made as follows:
 - i) where the Buyer provides the transport, delivery shall be made ex the Seller's works;
 - ii) where the Seller provides the transport, delivery shall be made to the premises of the Buyer, or the premises of the Buyer's customer or works site if the Buyer has requested delivery to be so made but where the Buyer has made such a request the Seller will make a first delivery to the Buyer's customer or works site as so much of the goods as is available for that delivery but subsequent deliveries will be made to the premises of the Buyer.
 - b) The Seller may at its discretion make partial delivery of orders and invoice the same.
 - c) Risk in the goods shall pass on delivery.
 - d) Where goods are sent FOB the Seller's responsibility shall cease when the goods are placed on board ship or aircraft without the need for the Seller to give notice to the Buyer and the provisions of Section 32(3) of the Sale of Goods Act 1979 shall not apply.
7. **OWNERSHIP OF GOODS:**
 - a) The goods shall remain the sole and absolute property of the Seller as legal and equitable owner until such time as the Buyer shall have paid to the Seller the contract price together with the full price of any other goods the subject of any contract between the Seller and the Buyer.
 - b) The Buyer acknowledges that until such time as the property in the goods passes to the Buyer he is in possession of the goods as a bailee and fiduciary agent for the Seller and the Purchaser shall store the goods in such a manner that they are clearly identifiable as the property of the Seller.
 - c) Until payment due under all contracts between the Buyer and the Seller had been made in full, in the event of sale of the goods by the Buyer:
 - i) the Seller shall be entitled to trace all proceeds of sale received by the Buyer through any bank or other account maintained by the Buyer; and
 - ii) the Buyer shall if requested by the Seller in writing to so assign its rights to recover the selling price of the goods from the third parties concerned. Such monies to be held separately by the Buyer as agent on behalf of the Seller.
 - d) The Seller may for the purpose of recovery of its goods enter upon any premises where they are stored or where they are reasonably thought to be stored and may repossess the same.
8. **TERMS OF PAYMENT:**

In the event of default in payment according to the agreed payment terms between the Seller and the Buyer - i.e. by the end of the month following the month of despatch of the goods the Seller shall be entitled without prejudice to any other right or remedy to suspend all further deliveries and to charge interest on any amount outstanding at the rate of 2% per month until payment in full is made (a part of a month being treated as a full month for the purpose of calculating interest).
9. **SHORTAGES AND DEFECTS APPARENT ON DELIVERY:**
 - a) It shall be the responsibility of the Buyer to inspect or arrange for an inspection of the goods on delivery whether the goods are delivered to the Buyer's premises or to the premises of the Buyer's customer or to a works site. If no such inspection is made the Buyer shall be deemed to have accepted the goods.
 - b) The Buyer shall have no claim for shortages or defects apparent on inspection unless:
 - i) a written complaint is made to the Seller within three days of receipt of the goods specifying the shortage or defect; and
 - ii) the Seller is within seven days of receipt of the complaint given an opportunity to inspect the goods and investigate the complaint before any use is made of the goods.
 - c) If a complaint is not made to the Seller as herein provided then in respect of such shortages or defects the goods shall be deemed to be in all respects in accordance with the contract and the Buyer shall be bound to pay for the same accordingly.
10. **CLAIMS FOR DEFECTS NOT APPARENT ON INSPECTION:**
 - a) The Buyer shall have no claim for defects not apparent on inspection unless the Seller is notified of defective workmanship or materials within twelve months from delivery of the goods. Provided that the goods have been installed and applied in accordance with any relevant recommendations made by the Seller, the Seller will at its option replace the goods or refund the net invoiced price in respect of the goods which have been shown to be defective. If the Seller does so supply substitute goods the Buyer shall be bound to accept such substituted goods in full satisfaction of the obligations of the Seller under the contract.
 - b) The Buyer shall in any event have no claim or set-off in respect of defects unless a written complaint is sent to the Seller as soon as the defect is noticed and no use is made of the goods thereafter or alteration made thereto by the Buyer before the Seller is given an opportunity to inspect the goods.
 - c) The Buyer is responsible for ensuring that the goods are fit for any particular purpose, and no warranty or condition of fitness for any particular purpose is to be implied into the contract.
11. **LIABILITY:**

Save as stated in Conditions 9 and 10 (and save in respect of death or personal injury resulting from the negligence of the Seller its servants or agents) the Seller shall not be liable for any claim or claims for direct or indirect consequential or incidental injury loss or damage made by the Buyer against the Seller whether in contract or in tort (including negligence on the part of the Seller its servants or agents) arising out of or in connection with any defect in the goods or their fitness or otherwise for any particular purpose or any act omission neglect or default of the Seller its servants or agents in the performance of the contract.
12. **FORCE MAJEURE:**

Notwithstanding anything herein contained neither the Buyer nor the Seller is to be held liable for any delay or failure to carry out the contract due wholly or in part to an act of God action by any Government whether British or foreign civil war strikes and/or lockouts wheresoever occurring fire trade disputes floods or unfavourable weather or any material becoming unavailable or irreplaceable (whether at all or at commercially acceptable prices) or any other circumstances beyond the control of the Seller.
13. **SUB-CONTRACTING:**

The Seller reserves the right to sub-contract the fulfilment of any order or any part thereof.
14. **INSOLVENCY AND BREACH OF CONTRACT:**

In the event that:

 - a) the Buyer commits any breach of the contract and fails to remedy such breach (if capable of remedy) within a period of thirty days from receipt of a notice in writing from the Seller requesting such remedy; or
 - b) any distress or execution is levied upon any of the goods or property of the Buyer; or
 - c) the Buyer offers to make any arrangements with or for the benefit of its creditors or (if an individual) becomes subject to a petition for a bankruptcy order or (being a limited company) has a receiver appointed of the whole or any part of its undertaking property or assets; or
 - d) an order is made or a resolution is passed or analogous proceedings are taken for the winding up of the Buyer (save for the purpose of reconstruction or amalgamation with insolvency and previously approved in writing by the Seller) the Seller shall thereupon be entitled without prejudice to its other rights hereunder forthwith to suspend all further deliveries until the default has been made good or to determine the contract and any unfulfilled part thereof or at the Seller's option to make partial deliveries. Notwithstanding any such termination the Buyer shall pay to the Seller at the contract rate for all the goods delivered up to and including the date of termination.
15. **INDUSTRIAL PROPERTY RIGHTS:**

If goods supplied by the Seller to the Buyer's design or specifications infringe or are alleged to infringe any patent or registered design right or copyright the Buyer will indemnify the Seller against all damages, costs and expenses incurred by the Seller as a result of the infringement or allegation. The Buyer will give the Seller all possible help in meeting any infringement claim brought against the Seller.
16. **BUYER'S ERROR IN ORDERING:**

In the event the Buyer orders incorrectly the Seller will be under no obligation to the Buyer to rectify or assist in rectifying the error.
17. **LAW AND JURISDICTION:**

The contract shall be subject in all respects to English Law and to the jurisdiction of the English Courts.

Durapipe UK reserves the right to modify the details in this publication as products and specifications are updated and improved.
The content of this publication is for general information only and it is the user's responsibility to determine the suitability of any product for the purpose intended.
For further information on all Durapipe UK products and services contact our Internal Sales Department as detailed below.
Durapipe UK is a trade name of Glynwed Pipe Systems Ltd. Company Number 1698059.

Registered office:

Durapipe UK
Walsall Road
Norton Canes
Cannock
Staffordshire
WS11 9NS
United Kingdom
Tel: +44 (0)1543 279909
Fax: +44 (0)1543 279450
email: enquiries@durapipe.co.uk
web: www.durapipe.co.uk

Distributor

04900238 February 2008